

***GPR-1600 Series
ppm Oxygen Analyzer***



Owner's Manual

Table of Contents

Introduction	1
Quality Control Certification	2
Safety & Installation	3
Features & Specifications	4
Operation	5
Maintenance	6
Spare Parts	7
Troubleshooting	8
Warranty	9
Material Safety Data Sheets	10

1 Introduction

Your new oxygen analyzer is a precision piece of equipment designed to give you years of use in variety of industrial oxygen applications.

This analyzer is designed to measure the oxygen concentration in inert gases, gaseous hydrocarbons, hydrogen, and a variety of gas mixtures. In order to derive maximum performance from your new oxygen analyzer, please read and follow the guidelines provided in this Owner's Manual.

The serial number of this analyzer may be found on the inside the analyzer. You should note the serial number in the space provided and retains this Owner's Manual as a permanent record of your purchase, for future reference and for warranty considerations.

Serial Number: _____

Every effort has been made to select the most reliable state of the art materials and components designed for superior performance and minimal cost of ownership. This analyzer was tested thoroughly by the manufacturer for best performance. However, modern electronic devices do require service from time to time. The warranty included herein plus a staff of trained professional technicians to quickly service your analyzer is your assurance that we stand behind every analyzer sold.

Advanced Instruments Inc. appreciates your business and pledge to make effort to maintain the highest possible quality standards with respect to product design, manufacturing and service.

2 Quality Control Certification

			<u>Pass</u>
Date:	Customer:	Order No.:	
Model:	GPR-1600 ppm Oxygen Analyzer	S/N _____	
Sensor:	() GPR-12-333 ppm Oxygen Sensor () XLT-12-333 ppm Oxygen Sensor	S/N _____	
Accessories:	Owner's Manual CABL-1008 Power Cord TOOL-1001 5/16" Combination Wrench		
Configuration:	Ranges: 0-1 ppm, 0-10 ppm, 0-100 ppm, 0-1000 ppm A-1146-10 PCB Assembly Main / Display Software V. _____ () A-1174-10 PCB Assy Power Supply / Interconnect, 4-20mA Range ID () A-1174-10C PCB Assy Power Supply / Interconnect, 5x Relay Contacts Range ID () Stainless steel sensor housing, manual flow control and bypass valves, ¼" compression type fittings for sample inlet and vent () Delete bypass valve from above (T and TO options) () Sample, span, zero inlet solenoid valves () Temperature controlled heater system 85°F specify: () 110VAC () 220VAC Power: 100/120/220/250 VAC (universal without temperature controlled heater systems) Enclosure: () Std. panel mount ("T") 7.5x10.8x12"; () "TO" option 7.75x 7.75x12" () Bezel for 19" rack mmount 19x12x12" option () GPR-1600-W option general purpose wall mount 12x12x8" () GPR-1600-W306 option general purpose panel mount 18.2x16x10"		
Test	System start-up diagnostics satisfactory Auto/manual range Alarm relays activate/deactivate with changes in O ₂ concentration Alarm bypass Analog outputs: Signal output 4-20mA Range ID: () 4-20mA or () 5x relay contacts plus 1x common Recovery from air to < 10 ppm in < 15 minutes Baseline drift on zero gas < ± 2% FS over 24 hour period Noise level < ± 1.0% FS Span calibration gas value Span adjustment within 10-50% FS Peak to peak over/under shoot < 0.5% FS Overall inspection for physical defects		
Options	Label analyzer "Oxygen Service" in accordance with P-1507 Rev-1; see certificate next page.		
Notes			

Certificate of Cleaning

Oxygen Service

Standard: Manufacturing Procedure No. P-1057 Rev-1,
Compressed Gas Association,
Publication: G-4.1 Edition 4,
Title: Cleaning Equipment for Oxygen Service,
Published 1/1/1996 and related publications

Mfg. Item No.: GPR-1600 Series
Description: ppm Oxygen Analyzer

Serial No.: _____

Customer: _____

Purchase Order: _____

Quantity: 1 of

Warranty Date: 12 months from _____

The undersigned warrants on behalf of Manufacturer that the product identified above conforms to the manufacturing, testing and packaging criteria set forth by the 'Standard' specified above.

Date: _____

Place: Pomona, CA

By print name: _____

Signature: _____

Title: _____

3 Safety Guidelines

Safety

This section summarizes the basic precautions applicable to all analyzers. Additional precautions specific to individual analyzer are contained in the following sections of this manual. To operate the analyzer safely and obtain maximum performance follow the basic guidelines outlined in this Owner's Manual.

Caution: This symbol is used throughout the Owner's Manual to **Caution** and alert the user to recommended safety and/or operating guidelines.

Danger: This symbol is used throughout the Owner's Manual to identify sources of immediate **Danger** such as the presence of hazardous voltages.

Read Instructions: Before operating the analyzer read the instructions.

Retain Instructions: The safety precautions and operating instructions found in the Owner's Manual should be retained for future reference.

Heed Warnings Follow Instructions: Follow all warnings on the analyzer, accessories (if any) and in this Owner's Manual. Observe all precautions and operating instructions. Failure to do so may result in personal injury or damage to the analyzer.

Heat: Situate and store the analyzer away from sources of heat.

Liquid and Object Entry: The analyzer should not be immersed in any liquid. Care should be taken so that liquids are not spilled into and objects do not fall into the inside of the analyzer.

Handling: Do not use force when using the switches and knobs. Before moving your analyzer be sure to disconnect the wiring/power cord and any cables connected to the output terminals located on the analyzer.

Maintenance

Serviceability: Except for replacing the oxygen sensor, there are no parts inside the analyzer for the operator to service. Only trained personnel with the authorization of their supervisor should conduct maintenance.

Oxygen Sensor: DO NOT open the sensor. The sensor contains a corrosive liquid electrolyte that could be harmful if touched or ingested, refer to the Material Safety Data Sheet contained in this Owner's Manual. Avoid contact with any liquid or crystal type powder in or around the sensor or sensor housing, as either could be a form of electrolyte. Leaking sensors should be disposed of in accordance with local regulations.

Troubleshooting: Consult the guidelines in section 8 for advice on the common operating errors before concluding that your analyzer is faulty. Do not attempt to service the analyzer beyond those means described in this Owner's Manual.

Do not attempt to make repairs by yourself as this will void the warranty, as detailed by section 9, and may result in electrical shock, injury or damage. All other servicing should be referred to qualified service personnel.

Cleaning: The analyzer should be cleaned only as recommended by the manufacturer. Wipe off dust and dirt from the outside of the unit with a soft damp cloth then dry immediately. Do not use solvents or chemicals.

Nonuse Periods: Disconnect the power when the analyzer is left unused for a long period of time.

Installation

Gas Sample Stream: Ensure the gas stream composition of the application is consistent with the specifications and review the application conditions before initiating the installation. Consult the factory to ensure the sample is suitable for analysis.

Contaminant Gases: A gas scrubber and flow indicator with integral metering valve are required upstream of the of the analyzer to remove interfering gases such as oxides of sulfur and nitrogen or hydrogen sulfide that can produce false readings, reduce the expected life of the sensor and void the sensor warranty if not identified at time of order placement. Installation of a suitable scrubber is required to remove the contaminant from the sample gas to prevent erroneous analysis readings and damage to the sensor or optional components. Consult the factory for recommendations concerning the proper selection and installation of components.

Expected Sensor Life: With reference to the publish specification located as the last page of this manual, the expected life of all oxygen sensors is predicated on oxygen concentration (< 1000 ppm or air), temperature (77°F/25°C) and pressure (1 atmosphere) in “normal” applications. As a rule of thumb sensor life is inversely proportional to changes in the parameters. Deviations are outside the specifications and will affect the life of the sensor. Avoid exposure to oxygen levels above 1% (10000 ppm) for hours at a time.

Failure to do so will result in damage to the sensor(s) as follows:

- GPR Series ppm sensors – reduced sensor life and loss of low end sensitivity (GPR sensor exposed continuously to the 20.9% content of air will last approximately 3.5 months and will develop a low end offset > 10-20 ppm);
- XLT Series ppm sensors - reduced sensor life and loss of low end sensitivity (XLT sensor exposed continuously to the 20.9% O2 content of air will last approximately 7 days and will develop a low end offset > 10-20 ppm)

Accuracy & Calibration: Refer to section 5 Operation. The 0-25% Range is provided only for the purpose of air calibration which is recommended only if span gas is not available. Bringing the analyzer back online after calibration with the 20.9% or 209,000 ppm oxygen content of air takes longer than calibrating the analyzer with a span gas containing 80 ppm or 800 ppm oxygen.

Materials: Assemble the necessary zero, purge and span gases and optional components such as valves, coalescing or particulate filters, and, pumps as dictated by the application; stainless steel tubing is essential for maintaining the integrity of the gas stream for ppm and percentage range (above or below ambient air) analysis; hardware for mounting.

Operating Temperature: The sample must be sufficiently cooled before it enters the analyzer and any optional components. A coiled 10 foot length of ¼” stainless steel tubing is sufficient for cooling sample gases as high as 1,800°F to ambient. The maximum operating temperature is 45° C on an intermittent basis unless the user is willing to accept a reduction in expected sensor life – refer to analyzer specification - where expected sensor life is specified at an oxygen concentration less than 1000 ppm oxygen for ppm analyzers and air (20.9% oxygen) for percent analyzers, but in all instances at 25°C and 1 atmosphere of pressure. Expected sensor varies inversely with changes in these parameters.

Pressure & Flow

All electrochemical oxygen sensors respond to partial pressure changes in oxygen. The sensors are equally capable of analyzing the oxygen content of a flowing sample gas stream or monitoring the oxygen concentration in ambient air (such as a confined space such in a control room or an open area such as a landfill or bio-pond).

Analyzers designed for in-situ ambient or area monitoring have no real inlet and vent pressure because the sensor is exposed directly to the sample gas and intended to operate at atmospheric pressure, however, slightly positive pressure has minimal effect on accuracy.

Sample systems and flowing gas samples are generally required for applications involving oxygen measurements below 1% and at a pressure other than ambient air. In these situations, the use of stainless steel tubing and fittings is critical to maintaining the integrity of the gas stream to be sampled and the inlet pressure must always be higher than the pressure at the outlet vent which is normally at atmospheric pressure.

The sensor is exposed to sample gas that must flow or be drawn through metal tubing inside the analyzer. The internal sample system includes 1/8” compression inlet and vent fittings, a stainless steel sensor housing with an o-ring seal to prevent the leakage of air and stainless steel tubing.

Inlet Pressure: Analyzers designed for flowing samples under positive pressure or pump vacuum (for samples at atmospheric or slightly negative atmospheres) that does not exceed 14" water column are equipped with bulkhead tube fitting connections on the side of the unit (unless otherwise indicated, either fitting can serve as inlet or vent) and are intended to operate at positive pressure regulated to between 5-30 psig although the rating of the fitting itself is considerably higher. **Caution:** If the analyzer is equipped with an optional H₂S scrubber, inlet pressure must not exceed 30 psig.

Outlet Pressure: In positive pressure applications the vent pressure must be less than the inlet, preferably atmospheric.

Flow Rate: Flow rates of 1-5 SCFH cause no appreciable change in the oxygen reading. However, flow rates above 5 SCFH generate backpressure and erroneous oxygen readings because the diameter of the integral tubing cannot evacuate the sample gas at the higher flow rate. The direction the sample gas flows is not important, thus either tube fitting can serve as the inlet or vent – just not simultaneously.

A flow valve upstream (with flow indicator positioned downstream) of the sensor is recommended as a means of controlling the flow rate of the sample gas, minimizing air leaks and produce optimum accuracy. A flow rate of 2 SCFH or 1 liter per minute is recommended for optimum performance.

Caution: Do not place your finger over the vent (it pressurizes the sensor) to test the flow indicator when gas is flowing to the sensor. Removing your finger (the restriction) generates a vacuum on the sensor and may damage the sensor (voiding the sensor warranty). To avoid generating a vacuum on the sensor (as described above) during operation, always select and install the vent fitting first and remove the vent fitting last.

Application Pressure - Positive: A flow indicator with integral metering valve positioned upstream of the sensor is recommended for controlling the sample flow rate between 1-5 SCFH. To reduce the possibility of leakage for low ppm measurements, position a metering needle valve upstream of the sensor to control the flow rate and position a flow indicator downstream of the sensor. If necessary, a pressure regulator (with a metallic diaphragm is recommended for optimum accuracy, the use of diaphragms of more permeable materials may result in erroneous readings) upstream of the flow control valve should be used to regulate the inlet pressure between 5-30 psig.

Caution: If the analyzer is equipped with a H₂S scrubber as part of an optional sample conditioning system, inlet pressure must not exceed 30 psig.

Application Pressure - Atmospheric or Slightly Negative: For accurate ppm range oxygen measurements, an optional external sampling pump should be positioned downstream of the sensor to draw the sample from the process, by the sensor and out to atmosphere. A flow meter is generally not necessary to obtain the recommended flow rate with most sampling pumps.

Caution: If the analyzer is equipped with an optional flow indicator with integral metering valve or a metering flow control valve upstream of the sensor - open the metering valve completely to avoid drawing a vacuum on the sensor and placing an undue burden on the pump. If pump loading is a consideration, a second throttle valve on the pump's inlet side may be necessary to provide a bypass path so the sample flow rate is within the above parameters.

Recommendations to avoid erroneous oxygen readings and damaging the sensor:

- Do not place your finger over the vent (it pressurizes the sensor) to test the flow indicator when gas is flowing to the sensor. Removing your finger (the restriction) generates a vacuum on the sensor and may damage the sensor (thus voiding the sensor warranty).
- Assure there are no restrictions in the sample or vent lines
- Avoid drawing a vacuum that exceeds 14" of water column pressure – unless done gradually
- Avoid excessive flow rates above 5 SCFH which generate backpressure on the sensor.
- Avoid sudden releases of backpressure that can severely damage the sensor.
- Avoid the collection of liquids or particulates on the sensor, they block the diffusion of oxygen into the sensor - wipe away.
- If the analyzer is equipped with an optional integral sampling pump (positioned downstream of the sensor) and a flow control metering valve (positioned upstream of the sensor), completely open the flow control metering valve to avoid drawing a vacuum on the sensor and placing an undue burden on the pump.

Moisture & Particulates: Installation of a suitable coalescing or particulate filter is required to remove condensation, moisture and/or particulates from the sample gas to prevent erroneous analysis readings and damage to the sensor or optional components. Moisture and/or particulates do not necessarily damage the sensor, however, collection on the sensing surface can block or inhibit the diffusion of sample gas into the sensor resulting in a reduction of sensor signal output – and the appearance of a sensor failure when in fact the problem is easily remedied by blowing on the front of the sensor. Consult the factory for recommendations concerning the proper selection and installation of components.

Moisture and/or particulates generally can be removed from the sensor by opening the sensor housing and either blowing on the sensing surface or gently wiping or brushing the sensing surface with damp cloth. **Caution:** Minimize the exposure of ppm sensors to air during this cleaning process. Air calibration followed by purging with zero or a gas with a low ppm oxygen concentration is recommended following the cleaning process. Moisture and/or particulates generally can be removed from the sample system by flowing the purge gas through the analyzer at a flow rate of 4.5-5 SCFH for an hour.

Mounting: The analyzer is approved for indoor use, outdoor use requires optional enclosures, consult factory. Mount as recommended by the manufacturer.

Gas Connections: Inlet and outlet vent gas lines for ppm analysis require 1/8" or 1/4" stainless steel compression fittings; hard plastic tubing with a low permeability factor can be used percentage range measurements.

Power: Supply power to the analyzer only as rated by the specification or markings on the analyzer enclosure. The wiring that connects the analyzer to the power source should be installed in accordance with recognized electrical standards. Ensure that is properly grounded and meets the requirements for area classification. Never yank wiring to remove it from a terminal connection. AC powered analog analyzers consume 5 watts, digital analyzers 50 watts without optional heaters. Optional 110V and 220V heaters AC powered heaters consume an additional 100-150 watts; DC powered digital analyzers consume 30 watts, 40 watts with the optional DC powered heater.

4 Features & Specifications

Technical Specifications

Accuracy:	< 1% of FS range under constant conditions
Analysis:	0-10 ppm, 0-100, 0-1000, 0-1%, 0-25% FS ranges; auto-ranging or manually lock on single range
Application:	Oxygen analysis from 100 ppb to 1% in inert, helium, hydrogen, mixed and acid (CO ₂) gas streams
Approvals:	CE
Area Classification:	General purpose
Alarms:	2 adjustable form C relay contacts non-latching; "weak sensor" indicator; power failure; system failure
Calibration:	Certified gas of O ₂ balance N ₂ approximating 80% of range above analysis range recommended for optimum results
Compensation:	Barometric pressure and temperature; optional heated sample system and sensor housing
Connections:	1/4" compression tube fittings
Controls:	Water resistant keypad; menu driven range selection, calibration, alarm and system functions
Data Acquisition:	Selectable data point intervals
Display:	Graphical LCD 5 x 2.75; resolution .001 ppm; displays real time ambient temperature and pressure
Enclosure:	Painted aluminum 7.5" x 10.8" x 12.25" panel mount
Flow Sensitivity:	None between 1-3 SCFH, 2 SCFH recommended
Linearity:	> .995 over all ranges
Pressure:	Inlet - regulate to 5-30 psig, max 100 psig; vent - atmospheric
Power:	Universal; specify 100/120 or 220/240 VAC with heater
Range ID:	4-20mA or 5x form C relay contacts plus common
Recovery Time:	60 seconds in air to < 10 ppm in < 1 hr on N ₂ purge
Response Time:	90% of final FS reading < 10 seconds
Sample System:	Flow control and sample/bypass valves; flow indicator
Sensitivity:	< 0.5% of FS range
Sensor Model:	GPR-12-333 - requires no maintenance
Sensor Life:	24 months at 25°C and 1 atm; average O ₂ < 1000 ppm
Signal Output:	4-20mA isolated and 0-1V
Temp. Range:	5° to 45°C
Warranty:	12 months analyzer; 12 months sensor
Wetted Parts:	Stainless steel

Optional Equipment

- XLT-12-333 ppm Oxygen Sensor with > 0.5% CO₂ present
- Bezel for 19" rack mounting; wall mount NEMA4 and 4X enclosures
- Temperature controlled heater system for elimination of drift and outdoor use
- Sample conditioning accessories - contact factory

GPR-1600 Series Process ppm O₂ Analyzer



Advanced Sensor Technology

- Accuracy < 1% FS Range
- Sensitivity < 0.5% FS Range
- Fast Recovery to < 10 ppm
- 24 Month Expected Life
- No Maintenance
- Compatible in 0-100% CO₂

Auto Zero, Span Calibration

5 Standard Analysis Ranges

Auto Ranging & Manual Selections

SS Bypass Sample System

Remote Communication Link

Certified ISO 9001 QA System

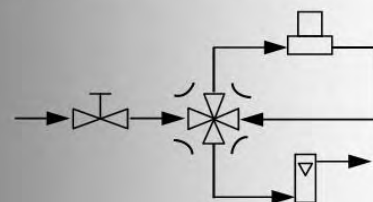

Sample System Increases Productivity

GPR-1600 W Process ppm O2 Analyzer

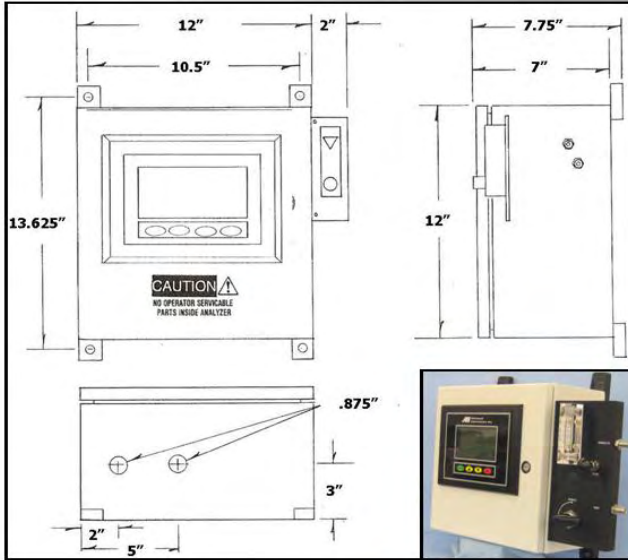

GPR-1600 W306 Process ppm O2 Analyzer

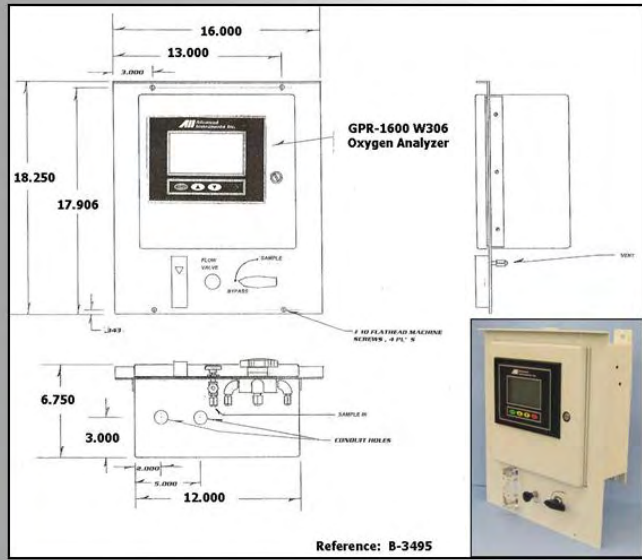

Sensor Housing

Constructed from stainless steel as are all wetted parts, this unique design features a compression type o-ring seal that virtually eliminate air leaks.

An APIMS mass spectrometer verified that the Bypass Sample System including this housing is capable of accurately and repeatedly distinguishing hourly changes of 1 ppb oxygen concentration.

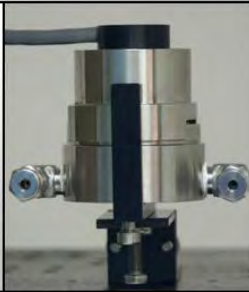

Bypass Sample System

Increases user productivity and ROI by protecting the sensor's ppm capability which enables the analyzer to come online at low ppm levels in a matter of minutes by isolating and protecting the sensor following:

- Transport (analyzer is shipped with the qualified sensor installed)
- Maintenance intervals when changing gas line connections
- Exposure to high oxygen levels during upset conditions
- Purging the air or high O2 levels when changing gas lines

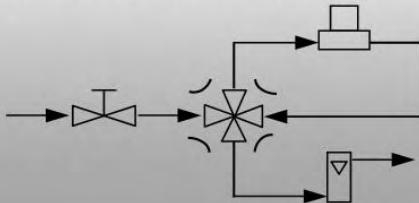

Advanced Sensor Technology

The sensor is the heart of any analyzer, thus the caliber of sensor technology is the critical factor in analyzer performance. Advanced Instruments focuses on optimizing the sensor to meet specific application needs and has produced the first real advancements in sensor technology in decades. All sensors are manufactured under an independently certified QA system that complies with ISO 9001:2000.

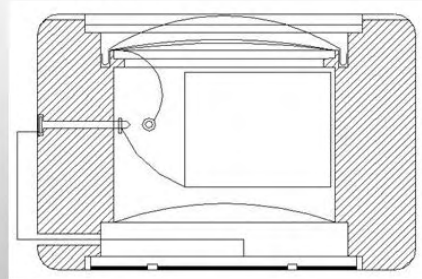

Galvanic ppm Oxygen Sensor

Advancements:

Signal output 2x higher
Innovative design, materials
Proprietary mfg process
Insensitive to vibration
Retain compact design
Low cost of ownership

Performance:

Accuracy $\pm 1\%$ FS
Sensitivity 0.5% FS (50 ppb)
Service life 24 mos < 100 ppm
Recovery air to 10 ppm < 1 hr.
Op temp -20°C in 0-100% CO₂
No sensor maintenance

5 Operation

Principle of Operation

The GPR-1600 ppm Oxygen Analyzers incorporate a variety of ppm range advanced galvanic fuel cell type sensors and is configured for panel mounting and requires a 7.5x10.8" (T configuration) cutout with 4 holes for the analyzer's front panel. Optional configurations include a panel mount (TO configuration) 7.75x7.75" with cutout; 19" bezel for rack mounting either the T or TO; 12x12x8" wall mount enclosure (GPR-1600W); 18.2x16x10" panel mount configuration (GPR-1600W-306) using the wall mount enclosure. Contact the factory for additional information on options. All configurations are tested and calibrated by the manufacturer prior to shipment. The GPR-1600 analyzers and sensors are CE certified and manufactured under a Quality Assurance System certified by an independent agency to ISO 9001:2000 standards.

Advanced Galvanic Sensor Technology

The sensors function on the same principle and are specific for oxygen. They measure the partial pressure of oxygen from low ppm to 100% levels in inert gases, gaseous hydrocarbons, helium, hydrogen, mixed gases, acid gas streams and ambient air. Oxygen, the fuel for this electrochemical transducer, diffusing into the sensor reacts chemically at the sensing electrode to produce an electrical current output proportional to the oxygen concentration in the gas phase. The sensor's signal output is linear over all ranges and remains virtually constant over its useful life. The sensor requires no maintenance and is easily and safely replaced at the end of its useful life.

Proprietary advancements in design and chemistry add significant advantages to an extremely versatile oxygen sensing technology. Sensors for low ppm analysis recover from air to ppm levels in minutes, exhibit longer life, extended operating range of -20°C to 50°C, excellent compatibility with CO₂ and acid gases (XLT series) and reliable quality giving them a significant advantage over the competition. Other advancements include extending the expected life of our new generation of percentage range sensors now range to five and ten years with faster response times and greater stability. Another significant development involves the first galvanic oxygen sensor capability of continuous oxygen purity measurements and expanding the operating temperature range from -40°C to 50°C.

Design Objectives

- Improve quality and reliability through a proprietary controlled manufacturing process . . .
- Comply with domestic and international quality standards
- Compact disposable dimensions
- No sensor maintenance
- Improve performance over replacement sensors - sensitivity, stability, response, recovery
- Longer operating and shelf life - translate into longer warranty period
- Low cost of ownership

ppm Oxygen Sensors

- Shorten manufacturing cycle from 4-6 weeks to 3-4 days
- Recovery to 10 ppm from oxygen shock or air . . .
in less than 1 hour on nitrogen purge
- Higher signal output to achieve . . .
50 ppb sensitivity
Enhanced stability, less temperature dependent
- Superior compatibility with 0.5 to 100% CO₂ gas streams
ppm O₂ contamination in natural gas
ppm O₂ contamination in beverage grade pure CO₂
- Operating life of 24 months in ppm O₂ concentrations
- Extended operating range -20°F to 50°F
- Develop special sensor for high ppm/low % applications

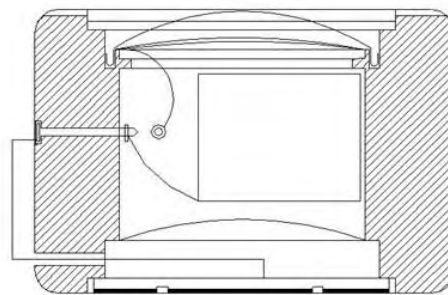

GPR/XLT 12 Series ppm Oxygen Sensor

Oxygen, the fuel for this electrochemical transducer, reacts chemically at the sensing electrode to produce an electrical current output proportional to the oxygen concentration in the gas phase. The sensor's signal output is linear over all four ranges and remains virtually constant over its useful life. The sensor requires no maintenance or electrolyte addition and is easily and safely replaced at the end of its useful life.

Electronics

The signal generated by the sensor is processed by state of the art low power micro-processor based digital circuitry. The first stage amplifies the signal. The second stage eliminates the low frequency noise. The third stage employs a high frequency filter and compensates for signal output variations caused by ambient temperature changes. The result is a very stable signal.

Sample oxygen is analyzed very accurately. Response time of 90% of full scale is less than 10 seconds (actual experience may vary due to the integrity of sample line connections, dead volume and flow rate selected) on all ranges under ambient monitoring conditions. Sensitivity is typically 0.5% of full scale low range.

Additional features of the micro-processor based electronics include manual or auto ranging, auto-zero and auto-cal, isolated 4-20mA signal for signal output and range ID, separate relay contacts rated 30VDC max @ 1A are provided for the alarm feature and an optional range ID feature (auto-zero/auto-cal with relay contacts for Range ID is special order, so . Whenever the analyzer is calibrated, a unique algorithm predicts and displays a message indicating a 'weak sensor' suggesting the sensor be replaced in the near future.

Sample System

The sample must be properly presented to the sensor to ensure an accurate measurement. In standard form the GPR-1600 is designed with a sample system that complements the performance capabilities of the advanced oxygen sensor and enables the user to isolate the sensor from exposure to high oxygen concentration which results in a substantial increase in user productivity. This bypass feature has two important features: one, the sensor can be isolated from exposure to high oxygen levels when changing sample lines, during transport and during standby intervals making it ideal for mobile cart applications. Two, it enables the user to purge newly connected gas lines of the oxygen trapped inside. The result is an analyzer that comes on-line at ppb levels in a matter of minutes and provides users with a significant increase in productivity.

For ppb and ppm trace oxygen measurements, the sensor is exposed to sample gas that must flow or be drawn through the analyzer's internal sample system. This unique sample system, when operated accordingly to the instructions in this Owner's Manual, can significantly increase user productivity by minimizing the sensor's exposure to ambient air or high oxygen concentrations which contribute to the significant amount of downtime associated with competitive analyzers.

SAMPLE SYSTEM: Galvanic Sensor

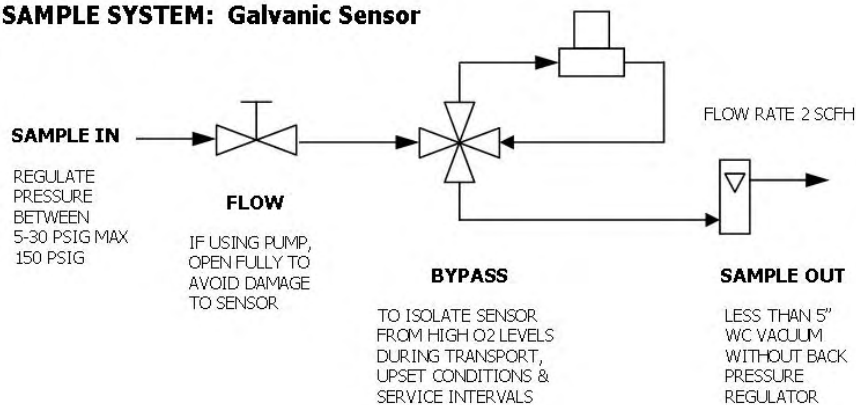

The advantages of the bypass sample system include:

- Supplying the analyzer with the sensor it was qualified with.
- Isolating the sensor during transport, calibration and maintenance intervals when changing gas line connections.
- Isolating the sensor from exposure to high oxygen levels during upset conditions which extends sensor life.
- Purging the air (or high oxygen levels above 1,000 ppm) trapped in the gas lines following a process upset.

Advanced Instruments Inc. offers a full line of sample handling, conditioning and expertise to meet your application requirements. Contact us at 909-392-6900 or e-mail us at info@aii1.com

Accuracy Overview

Single Point Calibration: As previously described the galvanic oxygen sensor generates an electrical current proportional to the oxygen concentration in the sample gas. In the absence of oxygen the sensor exhibits an absolute zero, e.g. the sensor does not generate a current output in the absence of oxygen. Given these linearity and absolute zero properties, single point calibration is possible.

Pressure: Because sensors are sensitive to the partial pressure of oxygen in the sample gas their output is a function of the number of molecules of oxygen 'per unit volume'. Readouts in percent are permissible only when the total pressure of the sample gas being analyzed remains constant. The pressure of the sample gas and that of the calibration gas(es) must be the same (reality < 1-2 psi).

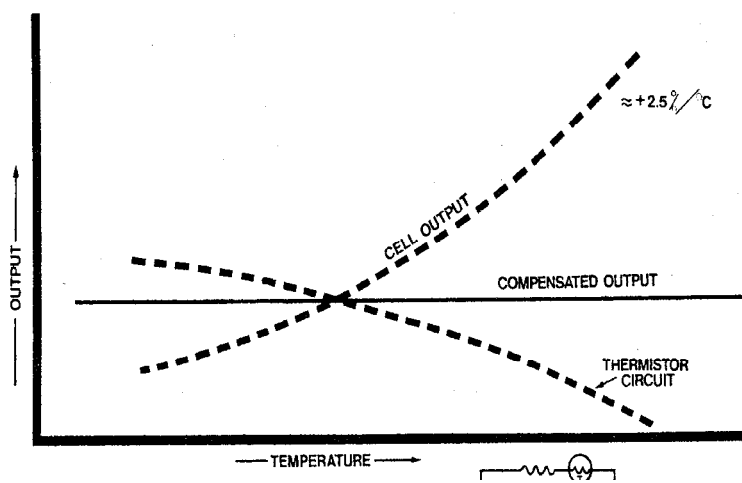

Temperature: The rate oxygen molecules diffuse into the sensor is controlled by a Teflon membrane otherwise known as an 'oxygen diffusion limiting barrier' and all diffusion processes are temperature sensitive, the fact the sensor's electrical output will vary with temperature is normal. This variation is relatively constant 2.5% per °C. A temperature compensation circuit employing a thermistor offsets this effect with an accuracy of $\pm 5\%$ or better and generates an output function that is independent of temperature. There is no error if the calibration and sampling are performed at the same temperature or if the measurement is made immediately after calibration. Lastly, small temperature variations of 10-15° produce < 1% error.

Accuracy: In light of the above parameters, the overall accuracy of an analyzer is affected by two types of errors:

- 1) those producing 'percent of reading errors', illustrated by Graph A below, such as $\pm 5\%$ temperature compensation circuit, tolerances of range resistors and the 'play' in the potentiometer used to make span adjustments and
- 2) those producing 'percent of full scale errors', illustrated by Graph B, such as $\pm 1-2\%$ linearity errors in readout devices, which are really minimal due to today's technology and the fact that other errors are 'spanned out' during calibration.

Graph C illustrates these 'worse case' specifications that are typically used to develop an analyzer's overall accuracy statement of < 1% of full scale at constant temperature or < 5% over the operating temperature range. QC testing is typically < 0.5% prior to shipment.

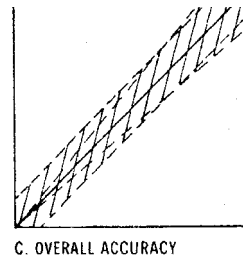
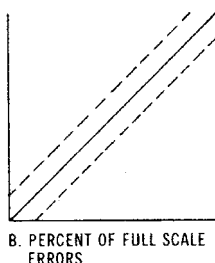
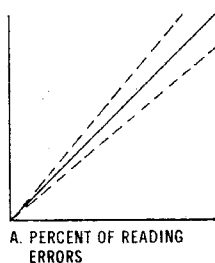

Example 1: As illustrated by Graph A any error, play in the multi-turn span pot or the temperature compensation circuit, during a span adjustment at 20.9% (air) of full scale range would be multiplied by a factor of 4.78 (100/20.9) if used for measurements of 95-100% oxygen concentrations. Conversely, an error during a span adjustment at 100% of full scale range is reduced proportionately for measurements of lower oxygen concentrations.

Refer to the Calibration section for additional details.

Mounting the Analyzer

The standard GPR-1600 is designed to be panel mounted and requires a cutout that accommodates the enclosure and 4 mounting bolts. The design also lends itself to 19" rack mounting with an optional bezel or wall mount enclosures as illustrated below.

Procedure:

1. The GPR-1600 is designed for panel mounting directly to any flat vertical surface, wall or bulkhead plate with the appropriate cut out and four 1/4" diameter holes for insertion of the mounting studs located on the back side of the front panel.
2. When mounting the analyzer position it approximately 5 feet off the floor for viewing purposes and allow sufficient room for access to the terminal connections at the rear of the enclosure.
3. **Note:** The proximity of the analyzer to the sample point and use of optional sample conditioning components have an impact on sample lag time.

Mounting GPR-1600:

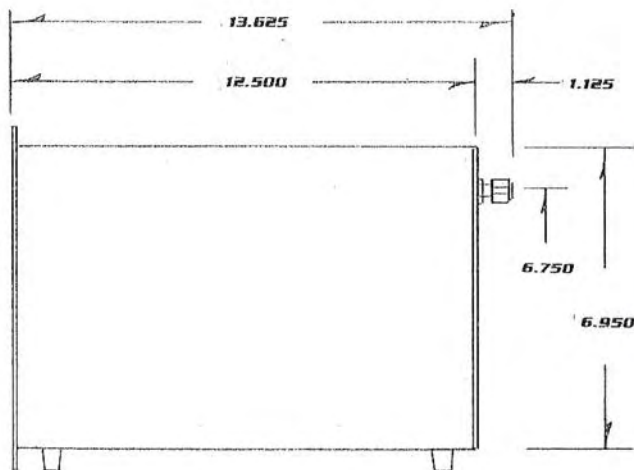
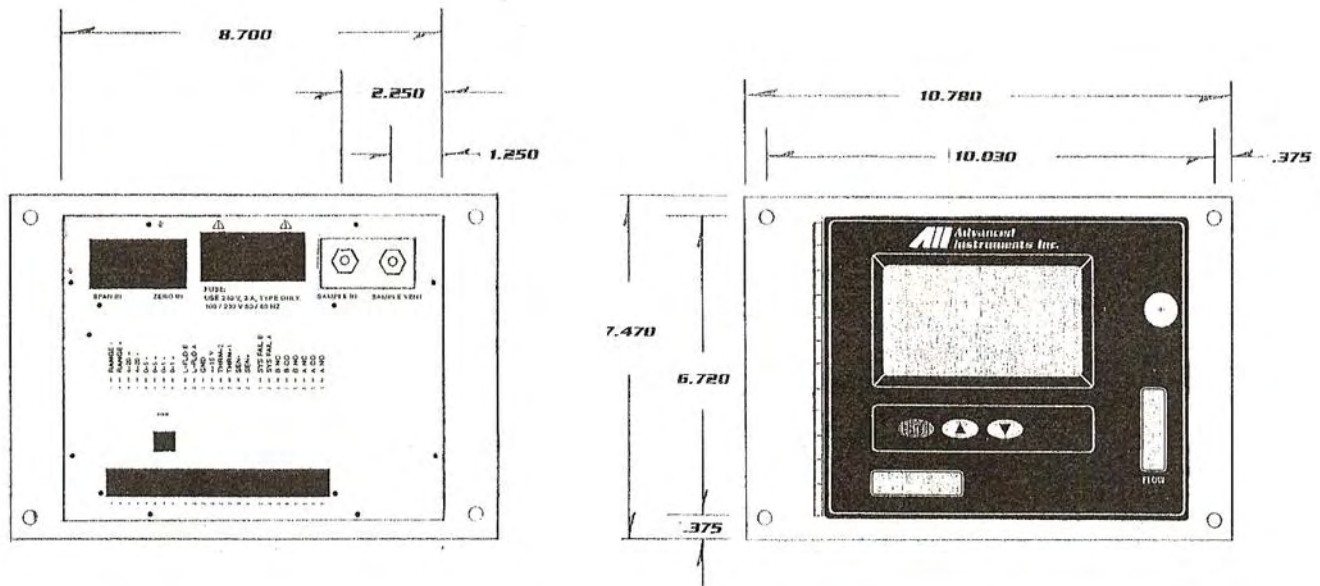

Mounting GPR-1600-W Option:

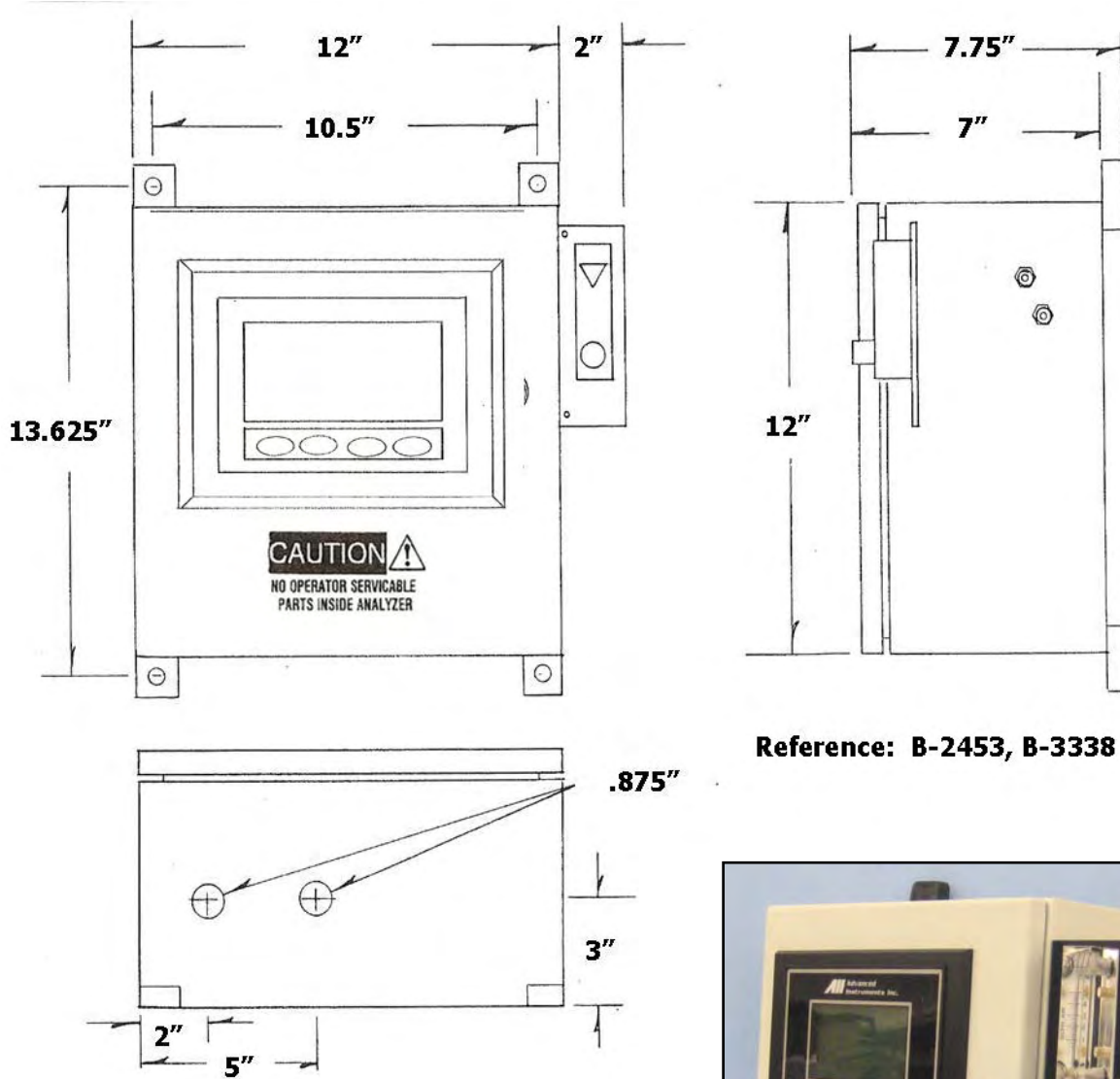

Reference: B-2453, B-3338



Mounting GPR-1600-W-306 Option:

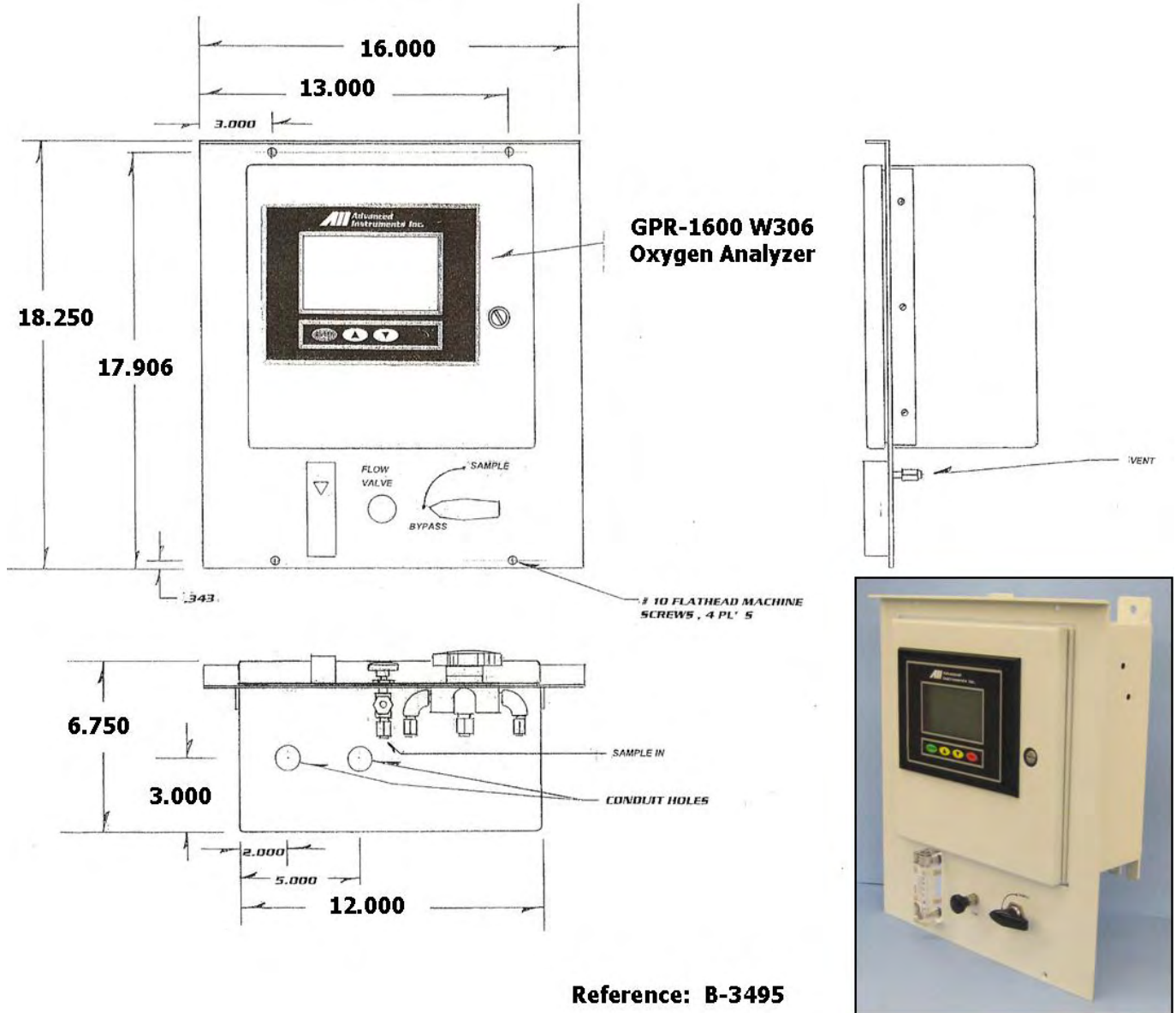

Gas Connections

The GPR-1600 with its standard flow through configuration is designed for positive pressure samples and requires connections for incoming sample and outgoing vent lines, see illustrations above.

The user is responsible for calibration gases and the components described below. Flow rates of 1-5 SCFH cause no appreciable change in the oxygen reading. A flow valve upstream (flow indicator downstream) of the sensor is recommended as a means of controlling the flow rate of the sample gas. A flow rate of 2 SCFH is recommended for optimum performance.

Caution: Do not place your finger over the fitting designated as the vent (it pressurizes the sensor) or to test the flow indicator when gas is flowing to the sensor. Removing your finger (the restriction) generates a vacuum on the sensor and may damage the sensor (voiding the sensor warranty).

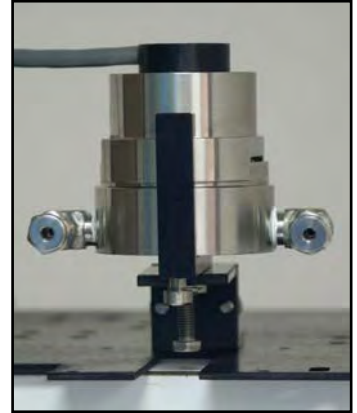

Procedure:

1. **Caution:** Do not change the factory setting until instructed.
2. Regulate the pressure and flow as described in Pressure & Flow above.
3. Install the sample out or vent line connection to the 1/8" dia. fitting labeled SAMPLE VENT.
4. Install the incoming sample or span gas line to the 1/8" dia. fitting labeled SAMPLE IN.
5. Set the flow rate to 1 SCFH (open the flow control valve completely if using an external sampling pump positioned downstream of the sensor).
6. Allow gas to flow through the analyzer for 3-5 minutes and proceed to Calibration or Sampling.

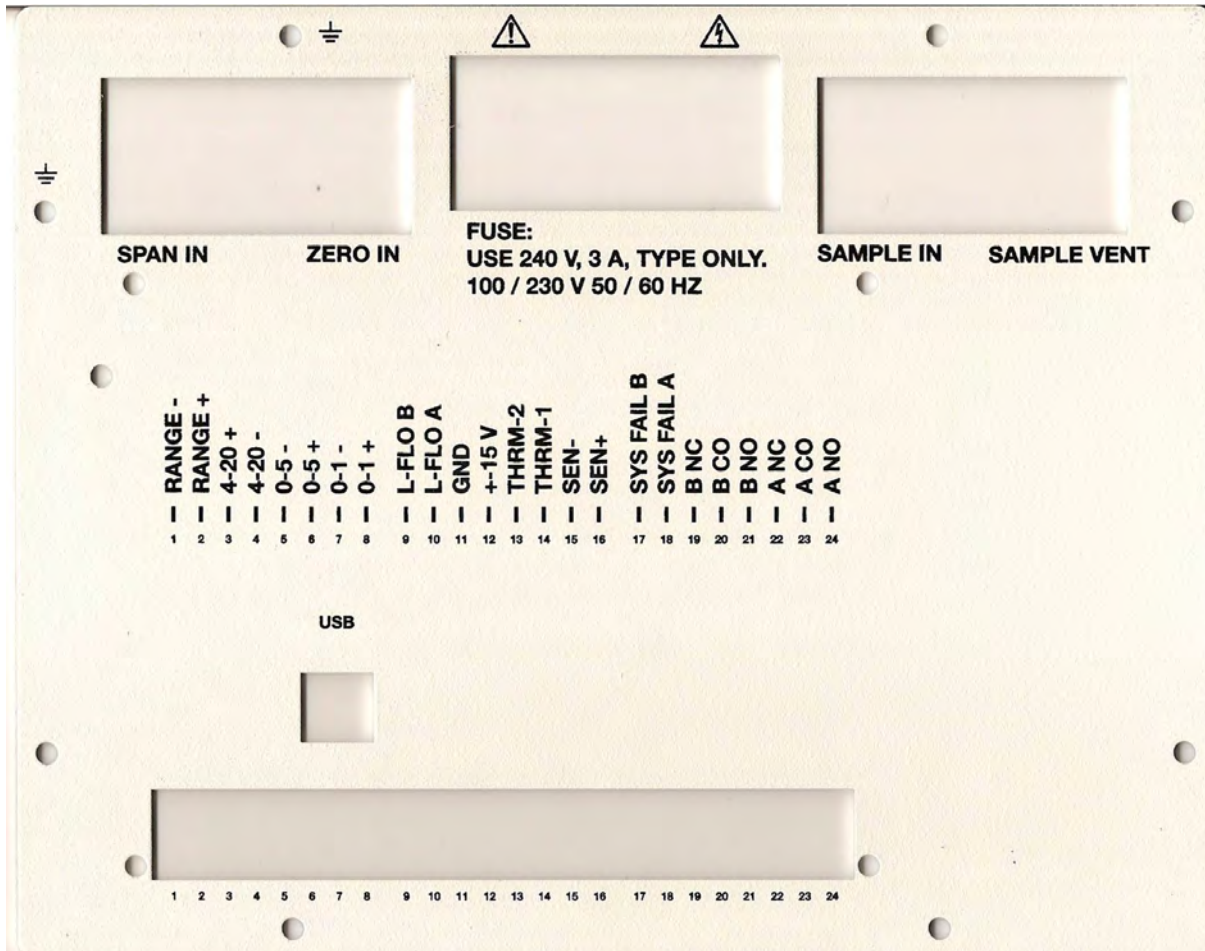

Electrical Connections:

Incoming power for the 100-250V AC powered analyzers is supplied through a universal power entry module. A standard computer type power cord (P/N A-1008) is required for the universal power entry module. A well grounded insulated power cable is recommended to avoid noise resulting from unwanted interference.

The appropriate AC power supply (110V or 220V) must be specified at order placement if the analyzer is to be equipped with proper the temperature control heater system.

Power consumption is approximately 150-200 watts with the temperature control heater system and 30 watts without.

Caution: Integral 4-20mA converters are internally powered and do not require external power. DO NOT supply any voltage to any of the terminals for 4-20mA signal output and range ID or **the 4-20mA converters will be damaged.**

Caution: To assure proper grounding, connect the 4-20mA signal output to the external device (PLC, DCS, etc.) before attempting any zero or span adjustments.

Optional Range ID:

The standard 4-20mA output used for range identification, as described below, can be replaced by eliminating the alarms feature and using the relay contacts associated with the alarms to provide a single common and four (4) normally open relay contacts that close when the related range is active. The dry contacts are rated at 30VDC @ 1A and powering them is not required if the PLC can distinguish contact closure via continuity check.

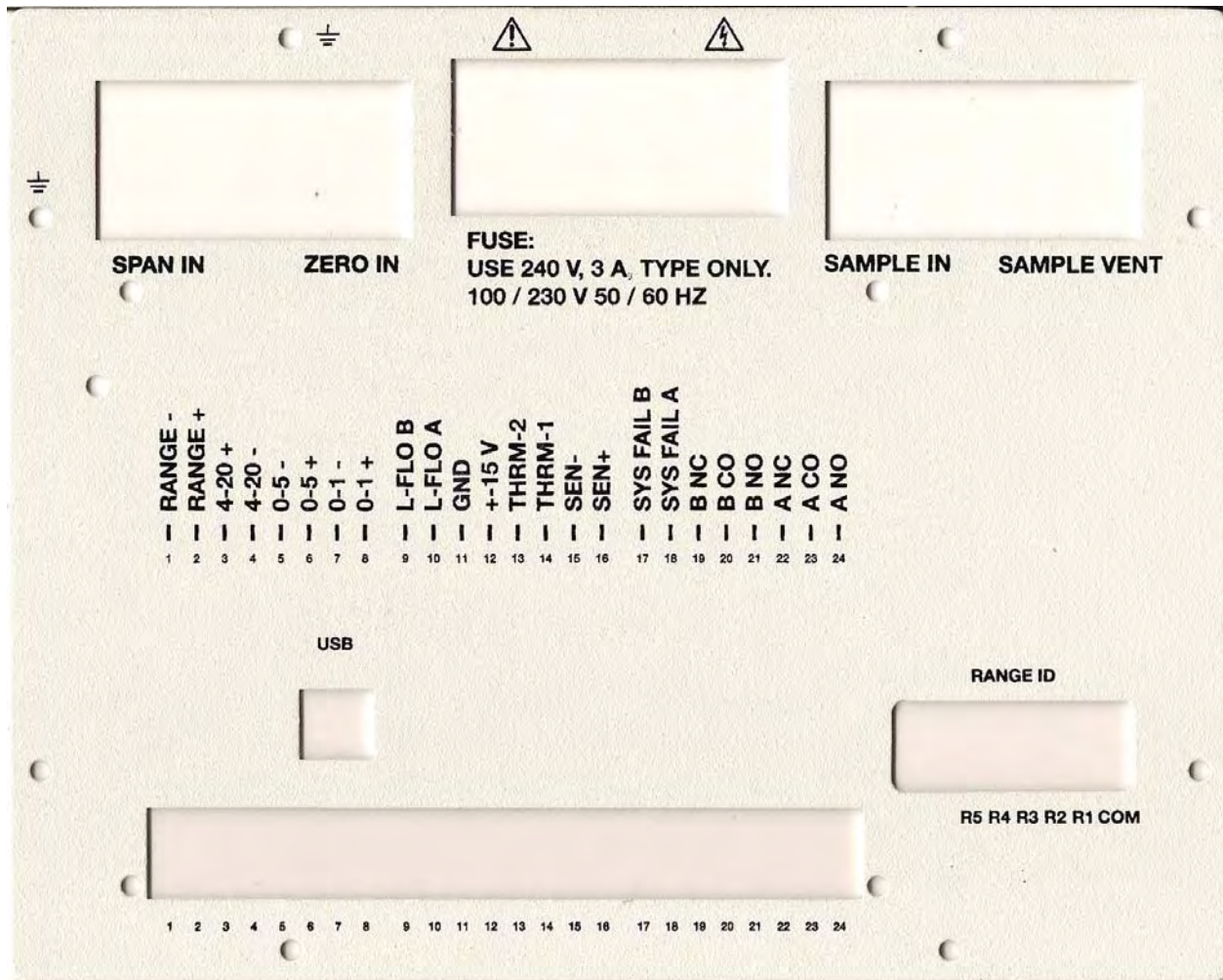

Advanced Instruments Inc.

Procedure:

1. As illustrated above the sensor, power and alarm relays and signal output connections are hard wired to screw type terminal blocks located at the rear of the analyzer.
2. Use a small bladed screwdriver to loosen the appropriate terminal screws as illustrated above.
3. Strip the wires of the cable no more than 3/16 inch.
4. To connect to an active relay or "fail safe", connect the live cable to the common terminal C and the secondary cable to the normally open NO terminal.
5. To break the connection upon relay activation, connect the secondary cable to the normally closed NC terminal.
6. Insert the stripped end of the cables into the appropriate terminal slots assuring no bare wire remains exposed that could come in contact with the back panel of the analyzer enclosure.
7. Tighten the terminal screws to secure the wires of the cable.

Danger: While connecting the cables to the relay terminals, ensure there is no voltage on the cables to prevent electric shock and possible damage to the analyzer. **Caution:** Assure the stripped wire ends of the cable are fully inserted into the terminal slots and do not touch each other or the back panel of the analyzer enclosure.

Interconnections for the optional wall mount enclosure pictured below.

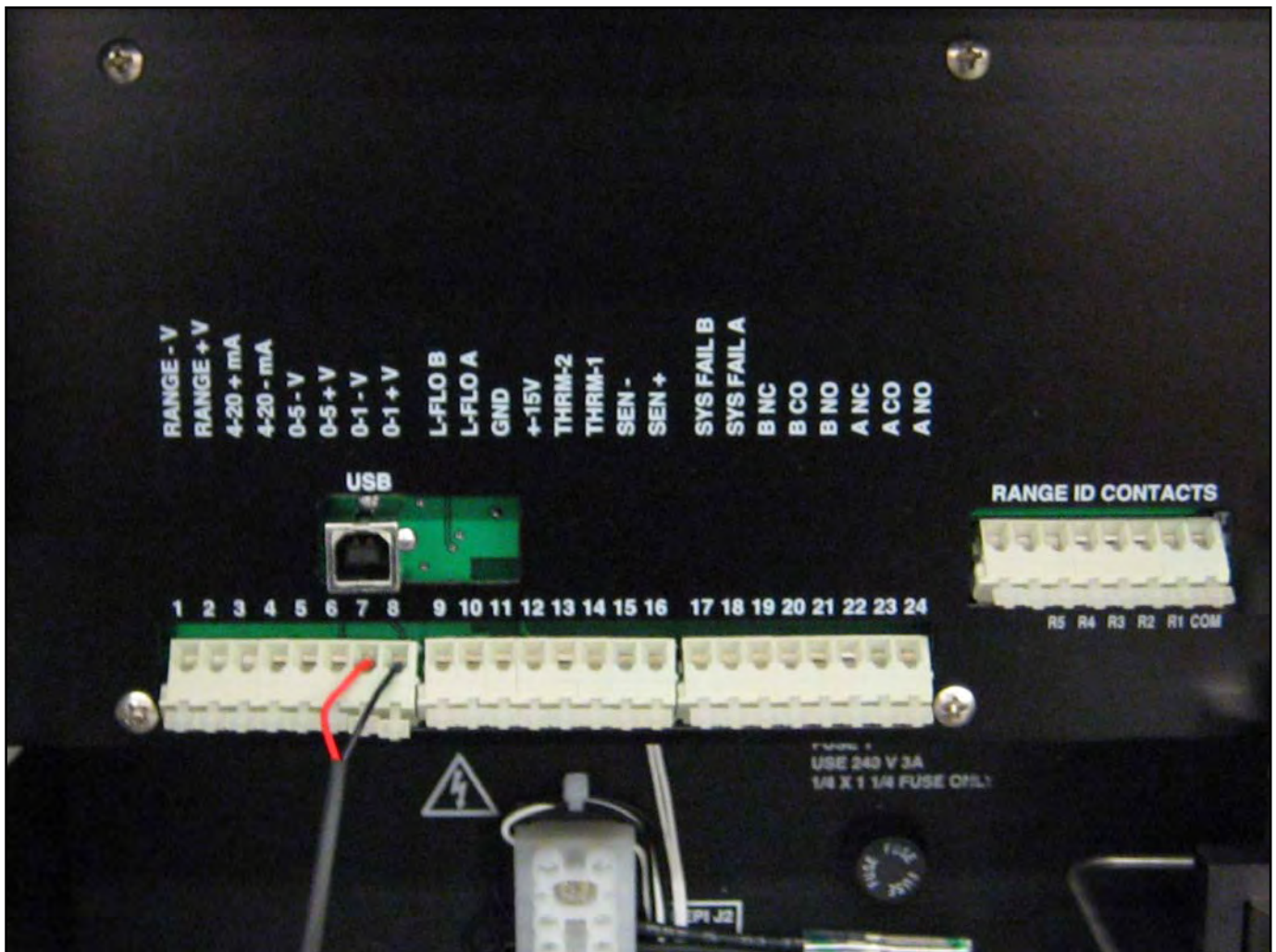

Alarms

The analyzer is configured with two user adjustable threshold type alarm relays that can be configured in the field from the ALARM option on the MAIN MENU as follows:

- Establish independent set points
- Either Hi or Lo
- Either On or Off (enabled or disabled)
- Both temporarily defeated using a user entered 'timeout' period (normally minutes)

The alarm set point represents a value. When the oxygen reading exceeds (high alarm) or falls below (low alarm) the alarm set point, the relay is activated and the LCD displays the alarm condition.

When activated the alarms trigger SPDT Form C non-latching relays @ 5A, 30VDC or 240VAC resistive. To prevent chattering of the relays, a 2% hysteresis is added to the alarm set point. This means that the alarm will remain active until the oxygen reading has fallen 2% below the alarm set point (high alarm) or risen 2% above the alarm set point (low alarm) after the alarm was activated. The timeout feature is useful while replacing the oxygen sensor or during calibration when the oxygen reading might well rise above the alarm set point and trigger a false alarm.

Note: When making connections the user must decide whether to configure/connect Alarm 1 and Alarm 2 in failsafe mode (Normally Open – NO – where the alarm relay de-energizes and closes in an alarm condition) or non-failsafe mode (Normally Closed – NC – where alarm relay energizes and opens in an alarm condition).

Power Failure Alarm

A dry contact rated at 30VDC @ 1A is provided as a power failure alarm that activates when power supplied to the analyzer's circuits is unacceptable. The contact is normally closed but opens when the power to the analyzer is switched off or interrupted and cannot be disabled.

4-20mA Signal Output

The analyzer provides a 4-20mA full scale fully isolated ground signals for external recording devices. The integral IC on the main PCB provides 4-20mA fully isolated signals for output and range ID. The 4-20mA current output is obtained by connecting the current measuring device between the positive and negative terminals labeled OUTPUT 4-20mA. To check the signal output of the 4-20mA E/I integrated circuit connect an ammeter as the measuring device and confirm the output is within ± 0.1 mA of 4mA. A finer adjustment of the zero offset of the 4-20mA converter can be provided by a potentiometer mounted on the main PCB Assembly. Consult factory for instructions

Range ID

For range ID the output of 4mA, 8mA, 12mA, 16mA, 20mA correspond to the most sensitive to least sensitive analysis range.

The standard 4-20mA output used for range identification, as described below, can be replaced by eliminating the alarms feature and using the relay contacts associated with the alarms to provide a single common and four (4) normally open relay contacts that close when the related range is active. The dry contacts are rated at 30VDC @ 1A and powering them is optional as some PLCs can distinguish contact closure via continuity check.

Caution: The integral 4-20mA converters are internally powered and do not require external power. DO NOT supply any voltage to any of the two terminals of the 4-20mA converter.

Temperature Controlled Heater System with Runaway Protection Circuit

The standard GPR-1600 Series analyzer is not equipped with the heater system. However, in anticipation of very low ppm (high ppb) oxygen analysis, the user may elect to add the heater system. If the analyzer is equipped with an optional temperature controlled heater system, open the front door of the analyzer to access it. This unit is a PID controller which operates between 0-99°F. The controller is programmed to maintain the temperature at 85°F.

Caution: Do not change this setting. A higher temperature setting may drastically reduce sensor life and possibly cause damage to the electronic circuitry of both the controller and the analyzer.

Warning: Keep the front door securely fastened and closed when the temperature controller is ON.

When power is applied to the temperature controller, the controller tunes itself to eliminate and/or minimize the over/under shoot of temperature from the set point. It is recommended that at initial start-up, when replacing the oxygen sensor or when trouble shooting, turn off the power to the heater or set the temperature set point at 60°F (to turn the heater off) to prevent overheating the analyzer. When operating the analyzer under normal conditions, set the temperature controller at 85°F.



Changing the display value from °F to °C:

1. Push the UP ARROW and ENTER buttons down for 5 seconds to access the SECURE MENU
2. Press INDEX to advance to the F-C MENU
3. Select °C or °F by pressing the UP ARROW key
4. Press the ENTER key when F-C starts flashing on the display
5. Press INDEX to exit the SECURE MENU

Heater Runaway Protection

Part of the optional temperature controlled heater system is a heater runaway protection circuit that protects the electronics in the event the temperature controller should fail and thereby allowing the heater to runaway damaging the components inside the analyzer.

The runaway protection is provided by a J2 type device positioned between the temperature controller and the heater. This device cuts-off power to the heater if the temperature inside the analyzer exceeds 70°C. Should the J2 device cut power to the heater, correct the problem and reset the runaway protector device by exposing it to 0°C for a few minutes (a refrigerator freezer will do).

Installing the Oxygen Sensor

The analyzer is equipped with an internal oxygen sensor that has been tested and calibrated by the manufacturer prior to shipment and is fully operational from the shipping containers. The sensor has been installed at the factory, however, it may be necessary to install the sensor in the field.

Caution: Review procedure before proceeding, mainly 2 and 9.

Caution: DO NOT open the oxygen sensor. The sensor contains a corrosive liquid electrolyte that could be harmful if touched or ingested, refer to the Material Safety Data Sheet contained in the Owner's Manual appendix. Avoid contact with any liquid or crystal type powder in or around the sensor or sensor housing, as either could be a form of electrolyte. Leaking sensors should be disposed of in manner similar to that of a common battery in accordance with local regulations.



Procedure:

1. The sensor has not been installed at the factory (in standard configuration there are no valves to isolate the sensor) and it will be necessary to install the sensor in the field.
2. As described above the following steps should already be completed:
 - a) Secure the sensor housing bracket with two 6/32 mounting screws, in the preferred position the upper section with the interconnection cable should be facing the ceiling;
 - b) connect the gas lines;
 - c) electrical connections.
1. **Caution:** Do not change the factory settings until instructed to do in this manual.
2. Purge the oxygen trapped in the newly connected gas lines for 3-5 minutes.
3. Flow zero gas or sample gas with a low ppm oxygen concentration to the analyzer at the predetermined flow rate of 1 SCFH.
4. Using the 5/16 wrench supplied loosen but do not remove the clamp bolt located under the sensor housing, see photo.
5. Rotate the upper section of the sensor housing 90° to disengage from the clamp.
6. Remove the upper section by pulling it straight up and place it on a smooth surface.
7. Select the AUTO RANGING option from the SAMPLE menu with gas flowing to the analyzer.
8. Remove the oxygen sensor from the bag and remove the red shorting device (including the gold ribbon) from the PCB located at the rear of the sensor.
9. Minimize the time the sensor is exposed to ambient air.
10. Immediately place the sensor in the bottom section of the sensor housing with the PCB facing up.
11. Immediately place the upper section of the sensor housing over the sensor, gently push the upper section downward and rotate 90° to engage the clamp.
12. Finger tighten the clamp bolt and then tighten it one full turn with the 5/16 wrench to securely lock the two sections of the sensor housing.
13. The analyzer will OVER RANGE for a short period of time as indicated by the graphical LCD display.
14. Wait until the display shows a meaningful oxygen reading and begins to approach the expected oxygen content of the sample gas.

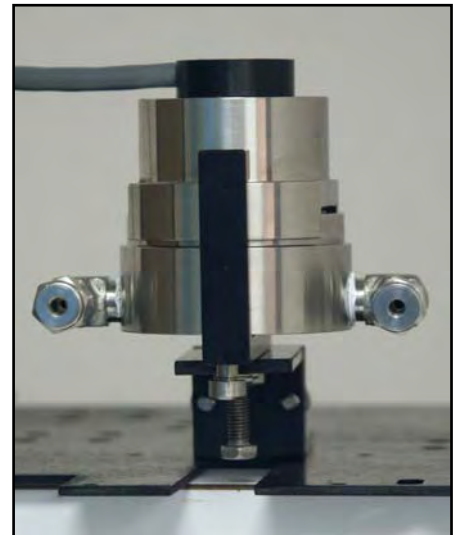

Span Gas Preparation

The analyzer must be calibrated periodically. See the Calibration section below for recommendations.

Caution: Do not contaminate the span gas cylinder when connecting the regulator. Bleed the air filled regulator (faster and more reliable than simply flowing the span gas) before attempting the initial calibration of the instrument.

Required components:

- Certified span gas cylinder with an oxygen concentration, balance nitrogen, approximating 80% of the full scale range above the intended measuring range.
- Regulator to reduce pressure to 30 psig.
- Flow meter to set the flow between 1 SCFH,
- Suitable fittings and 1/8" dia. 4-6 ft. in length of metal tubing to connect the regulator to the flow meter inlet
- Suitable fitting and 1/8" dia. 4-6 ft. in length of metal tubing to connect from the flow meter vent to tube fitting designated SAMPLE IN on the GPR-1600.

Procedure:

1. With the span gas cylinder valve closed, install the regulator on the cylinder.
2. Open the regulator's exit valve and partially open the pressure regulator's control knob.
3. Open slightly the cylinder valve.
4. Loosen the nut connecting the regulator to the cylinder and bleed the pressure regulator.
5. Retighten the nut connecting the regulator to the cylinder
6. Adjust the regulator exit valve and slowly bleed the pressure regulator.
7. Open the cylinder valve completely.
8. Set the pressure between 5-30 psig using the pressure regulator's control knob.
9. **Caution:** Do not exceed the recommended flow rate. Excessive flow rate could cause the backpressure on the sensor and may result in erroneous readings and permanent damage to the sensor.

Establishing Power to the Electronics:

Once the power to the electronics is established, the digital display responds instantaneously. When power is applied, the analyzer performs several diagnostic system status checks termed "SYSTEM SELF TEST" as illustrated below:

System Self Test	
CPU	OK
Memory	OK
RTC	OK
Analog	OK

GPR Series Oxygen Analyzer
Software Version X.XX
Advanced Instruments
2855 Metropolitan Place
Pomona, CA 91767
Tel: 909-392-6900
Fax: 909-392-3665
e-mail: info@a11.com

After 3 seconds the system defaults to the STANDBY mode and the LCD displays the following:

* MAIN MENU	Standby
Sample	
Span	
Zero	
Alarm	
System	
Standby	
Auto Range	
85°F	100Kpa 12/31/07 12:00:00

Menu Format

Menu displayed – displayed on the top line in the upper left corner of the display.

Menu options available - displayed in the upper left corner of the display under the current menu on the top line.

Menu option selected - indicated by the cursor (*) positioned to the left of the menu option selected.

System mode - indicated at the top center of the display.

Range mode and current auto or fixed manual range - displayed on the first line at the bottom of the display.

Temperature inside the analyzer and ambient pressure - displayed on the second line at the bottom of the display.



Note: In the event power to the analyzer is interrupted, the system defaults to the “Standby” mode when power is restored. To resume sampling, advance the cursor (*) to “Sample” mode, press ENTER to select and select the range mode as described below.

Menu Navigation

The four (4) pushbuttons located on the front of the analyzer control the system’s micro-processor:

1. Green - ENTER (select)
2. Yellow UP ARROW – advance cursor up
3. Yellow DOWN ARROW – advance cursor down
4. Red – ESC (menu)

Select menu option by advancing cursor (*) by repeatedly pressing the yellow UP/DOWN ARROW keys.

Accept the menu option selected with cursor (*) by pressing the green ENTER key.

Abort the menu option selected with cursor (*) and return to the previous menu by pressing the red ESC key.

Note: If a selection is not made within 30 seconds, the system returns to the MAIN MENU.

Range Mode Selection

Advance the cursor (*) to the "Sample" option as illustrated and press the green ENTER key to accept the selection.

MAIN MENU	Standby
* Sample	
Span	
Zero	
Alarm	
System	
Standby	
Auto Range	
85°F	100Kpa 12/31/07 12:00:00

The following menu appears:

* SAMPLE	Standby
Auto Range	
Manual Range	
Bypass	
Standby	
Auto Range	
85°F	100Kpa 12/31/07 12:00:00

The analyzer is equipped with five (5) standard measuring ranges (see specification) and provides users with a choice of sampling modes. By accessing the MAIN MENU, users may select either the Auto Range or a fixed Manual Range) mode.

Note: For calibration purposes, use of the Auto Range mode is recommended. However, the user can select a fixed Manual Range (full scale) as dictated by the oxygen content of the calibration gas.

Auto Range Sampling

The display will shift to the next higher range when the oxygen reading exceeds 99.9% of the current range. The display will shift to the next lower range when the oxygen reading drops to 85% of the next lower range.

For example, if the analyzer is reading 1 ppm on the 0-10 ppm range and an upset occurs, the display will shift to the 0-100 ppm range when the oxygen reading exceeds 9.99 ppm. Conversely, once the upset condition is corrected, the display will shift back to the 0-10 ppm range when the oxygen reading drops to 8.5 ppm.

Procedure: From the SAMPLE menu, advance the cursor (*) to the "Auto Range" option and press ENTER:

SAMPLE	Standby
* Auto Range	
Manual Range	
Bypass	
Standby	
Auto Range	
85°F	100Kpa 12/31/07 12:00:00

Note: To provide for the possibility of an optional automated sample system, the system displays the message "Opening Sample Valves" at this time. This message does not apply to analyzers equipped with the standard manually operated sample system.

Similarly, the Bypass and Standby options do not apply to analyzers equipped with manual sample systems.

Within seconds the system assesses the oxygen concentration, selects the appropriate range (as described above) and returns to the MAIN MENU in the "Sample" mode. On the top line at the bottom of the menu, the Auto Range mode is indicated as the current full scale range.

* MAIN MENU	Sample
Sample	
Span	
Zero	
Alarm	
System	
Standby	
5.00 PPM	
Auto Range 0 to 10 PPM	
85°F	100Kpa 12/31/07 12:00:00

Manual Range Sampling

The display will not shift automatically. Instead, when the oxygen reading exceeds 125% of the upper limit of the current range an OVER RANGE warning will be displayed. Once the OVER RANGE warning appears the user must advance the analyzer to the next higher range.

Procedure: From the SAMPLE menu, advance the cursor (*) to the "Manual Range" option and press ENTER:

SAMPLE	Standby
Auto Range	
* Manual Range	
Bypass	
Standby	
Auto Range	
85°F	100Kpa 12/31/07 12:00:00

The following display appears:

MANUAL RANGE	Standby
0 to 25%	
0 to 1%	
0 to 1000 PPM	
0 to 100 PPM	
* 0 to 10 PPM	
Auto Range	
85°F	100Kpa 12/31/07 12:00:00

Advance the cursor (*) to the desired fixed manual range, e.g. 0 to 10 ppm and press ENTER.

Within seconds the system assesses the oxygen concentration and returns to the MAIN MENU in the "Sample" mode. On the top line at the bottom of the menu, the Manual Range mode is indicated as is the fixed full scale range selected.

* MAIN MENU	Sample
Sample	
Span	
Zero	
Alarm	
System	
Standby	
	5.00 PPM
Manual Range	0 to 10 PPM
85°F	100Kpa 12/31/07 12:00:00

If the oxygen reading exceeds 99.9% of the full scale fixed range manually selected, the system displays the following:

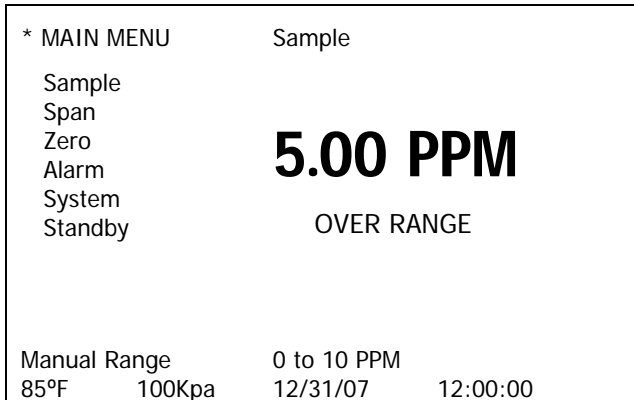

Alarms

The analyzer is configured with two user adjustable threshold type alarm relays that can be configured in the field from the ALARM option on the MAIN MENU as follows:

- Establish independent set points
- Either Hi or Lo
- Either On or Off (enabled or disabled)
- Both temporarily defeated using a user entered 'timeout' period (normally minutes)

The alarm set point represents a value. When the oxygen reading exceeds (high alarm) or falls below (low alarm) the alarm set point, the relay is activated and the LCD displays the alarm condition.

When activated the alarms trigger SPDT Form C non-latching relays @ 5A, 30VDC or 240VAC resistive. To prevent chattering of the relays, a 2% hysteresis is added to the alarm set point. This means that the alarm will remain active until the oxygen reading has fallen 2% below the alarm set point (high alarm) or risen 2% above the alarm set point (low alarm) after the alarm was activated. The timeout feature is useful while replacing the oxygen sensor or during calibration when the oxygen reading might well rise above the alarm set point and trigger a false alarm.

Note: When making connections the user must decide whether to configure/connect Alarm 1 and Alarm 2 in failsafe mode (Normally Open – NO – where the alarm relay de-energizes and closes in an alarm condition) or non-failsafe mode (Normally Closed – NC – where alarm relay energizes and opens in an alarm condition).

Procedure: Advance the cursor (*) to the "Alarm" option and press the green ENTER key to accept the selection.

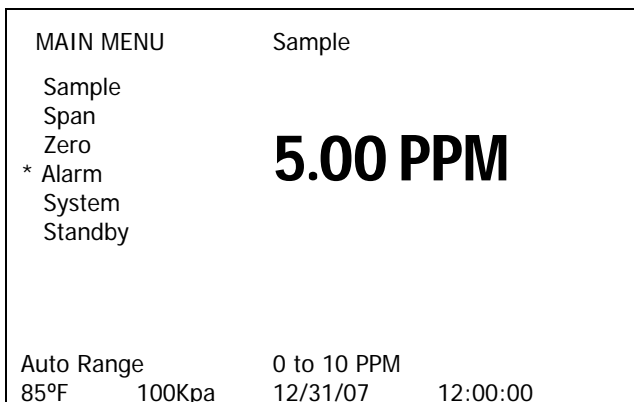

The following menu appears:

ALARM	Sample
* Set Alarm 1	
Set Alarm 2	
Alarm 1 HI	
Alarm 2 HI	
Alarm 1 ON	
Alarm 2 ON	
Alarm Timeout	
Auto Range	0 to 10 PPM
85°F 100Kpa	12/31/07 12:00:00

Advance the cursor (*) to the "Set Alarm 1" option and press the green ENTER key to accept the selection. The following menu appears:

	Sample
20%	
Press UP or DOWN	
to change value	
ENTER to Save	
ESC to Return	
Auto Range	0 to 10 PPM
85°F 100Kpa	12/31/07 12:00:00

Follow the prompt above and press the ENTER key to save the alarm value (% full scale) or ESC to return to the MAIN MENU. Within a few seconds after pressing the ENTER key, the system returns to the MAIN MENU.

Repeat the above steps for "Set Alarm 2".

Configure Alarm 1 and Alarm 2 by advancing the cursor (*) to the desired feature as illustrated below.

ALARM	Sample
Set Alarm 1	
Set Alarm 2	
* Alarm 1 HI / LO	
* Alarm 2 HI / LO	
* Alarm 1 ON / OFF	
* Alarm 2 ON / OFF	
Alarm Timeout	
Auto Range	0 to 10 PPM
85°F 100Kpa	12/31/07 12:00:00

Press the ENTER key to toggle between the settings: HI and LO and/or ON and OFF. After toggling, the system returns to the MAIN MENU. To confirm selection, re-access the ALARM menu above. Advance the cursor (*) to the "Alarm" option and press the green ENTER key to accept the selection.

MAIN MENU	Sample
Sample	
Span	
Zero	
* Alarm	5.00 PPM
System	
Standby	
Auto Range	0 to 10 PPM
85°F 100Kpa	12/31/07 12:00:00

The following menu appears:

ALARM	Sample
Set Alarm 1	
Set Alarm 2	
Alarm 1 HI	
Alarm 2 HI	
Alarm 1 ON	
Alarm 2 ON	
* Alarm Timeout	
Auto Range	0 to 10 PPM
85°F 100Kpa	12/31/07 12:00:00

Advance the cursor (*) to the "Alarm Timeout" option and press the green ENTER key to accept the selection. The following menu appears:

	Sample
20 Minutes	
Press UP or DOWN	
to change value	
ENTER to Save	
ESC to Return	
Auto Range	0 to 10 PPM
85°F 100Kpa	12/31/07 12:00:00

Follow the prompt above and press the ENTER key to save the alarm timeout value or ESC to return to the MAIN MENU. Within a few seconds after pressing the ENTER key, the system returns to the MAIN MENU.

System Menu

The analyzer is equipped with a wide range of features that enables users to enhance performance and tailor their interface with the analyzer. The SYSTEM menu shown below lists the features available and is followed by a description of each function. Most of the functions are initiated by toggling between options using the ENTER key as previously described.

Advance the cursor (*) to the "Alarm" option and press the green ENTER key to accept the selection.

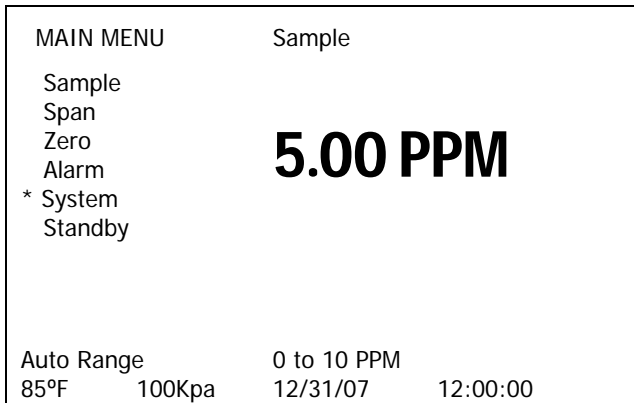

The following menu appears:

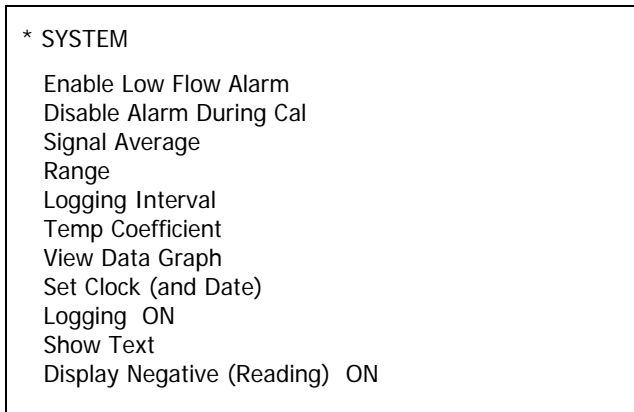

Advance the cursor (*) to the desired option and press follow the instructions below.

Enable Low Flow Alarm	If the analyzer is equipped with a low flow alarm, press ENTER key to toggle between ENABLE and DISABLE.
Disable Alarm During Cal	Press ENTER key to toggle between ENABLE and DISABLE.
Signal Average	Press ENTER key to select and choose Low, Medium (default) or High – functions allows users to select their preference regarding the trade-off of response time vs. noise filtering.
Range	Same as Manual Range option found on SAMPLE menu.
Logging Interval	Press ENTER key and a display appears similar to Alarm Timeout above for the user to enter the interval in minutes for capturing data points for logging purposes.
Temp Coefficient	Not operable at this time.

View Data Graph	Provided "Logging" feature below is toggled ON, selecting this feature provides a fullscreen display or graph of the data points.
Set Clock (and Date)	Selecting this option generates a display for selecting Time or Date with each followed by a detailed display for setting hour, minute, second or year, month, day.
Logging	Press ENTER key to toggle between ON and OFF.
Show Text	Press ENTER key to toggle between MAIN MENU display options: 1.) Menu text with large numbers (as illustrated herein) 2.) Menu text with small numbers and a small graph of O2 reading.
Display Negative (Reading)	Press the ENTER key to toggle between ON and OFF.

Installation & Start-up is now complete . . .

Calibration

The electrochemical oxygen sensors manufactured by Analytical Industries Inc. (dba Advanced Instruments) generate an electrical current that is **linear** or proportional to the oxygen concentration in the sample gas. In the absence of oxygen the sensor exhibits an **absolute zero**, e.g. the sensor does not generate a current output in the absence of oxygen. Given the properties of linearity and an absolute zero, single point calibration is possible.

As described below, zero calibration is recommended only when the application (or user) demands optimum accuracy for analysis below 5% of the most sensitive or lowest range available on the analyzer. Span calibration in one of the forms described below is sufficient for all other measurements. When employed zero calibration should precede span calibration.

Zero Calibration

Despite the absolute zero inherent in electrochemical oxygen sensors, the reality is that analyzers display an oxygen reading when sampling a zero gas due to:

- Contamination or quality of the zero gas
- Minor leakage in the sample line connections
- Residual oxygen dissolved in the sensor's electrolyte
- Tolerances of the electronic components

The zero capability (low end sensitivity) of every analyzer is qualified prior to shipment. However, because the factory sample system conditions differ from that of the user, no ZERO OFFSET adjustment is made to the analyzer by the factory

Span Calibration

Involves periodically, see Intervals section below, checking and/or adjusting the electronics to the sensor's signal output at a given oxygen standard or span. Maximum drift from calibration temperature is approximately 0.11% of reading per °C. The frequency of calibration varies with the application conditions (potential for contamination), the degree of accuracy required by the application and the quality requirements of the user. However, the interval between span calibrations should not exceed three (3) months.

Note: Regardless of the oxygen concentration of the standard used, the span calibration process takes approximately 10 minutes, however, the time required to bring a ppm analyzer back on-line can vary, see Online Recovery Time below.

Considerations

When it comes to the calibration of oxygen analyzers utilizing an electrochemical oxygen sensor circumstances vary widely from the ideal conditions that exist at the factory to a variety of differing circumstances users encounter in the field. The following describes the most common factors and reasons that they influence the calibration procedures.

Factor	Reasons
Intervals:	All electrochemical sensor based analyzers require periodic, e.g. weekly intervals to a 3 month maximum, calibration to ensure accuracy and ascertain whether the sensor has been contaminated or otherwise damaged while in service.
Conditions:	Calibrate at the temperature and pressure of the sample.
Analysis Level Required:	Continuous analysis below 5% of the most sensitive or lowest range available: ZERO CALIBRATION followed by SPAN CALIBRATION with good quality gases is recommended (for optimum accuracy) when: <ul style="list-style-type: none">- the analyzer and/or O₂ sensor is initially installed,- the sample system connections are modified,- the O₂ sensor is replaced.

Note: It is not necessary to repeat the ZERO CALIBRATION with subsequent periodic SPAN CALIBRATION unless desired or one of the above events occurs.

All other analysis: SPAN CALIBRATION is sufficient. Procedure varies with factors.

Zero Calibration Offset Adjustment Capability:

Designed to facilitate precise analysis below 5% of the most sensitive or lowest range available on the analyzer, this feature enables users' to compensate for background offsets, as defined above, of up to 50% of the most sensitive or lowest full scale range available on the analyzer and bring analyzers online faster.

As described below, accomplishing either objective places a degree of responsibility on the user. Determining the true offset requires the user to wait, see Online Recovery Time section, until the analyzer reading is no longer trending downward (best evidenced by a constant horizontal trend on an external recording device). Bringing the analyzer online faster, basically the same as choosing not to wait for the stable horizontal trend reading, requires the user to repeat the ZERO CALIBRATION function. The frequency of which is at the user's discretion, hourly is recommended but at least when the reading goes negative.

Advanced Instruments' oxygen analyzers are capable of zero offset adjustments of 50% of the most sensitive or lowest range available on the analyzer. Since every analyzer is QC tested to 1% of the most sensitive or lowest range available, exercise **CAUTION** when initiating the ZERO CALIBRATION function at 50% (prematurely) of the most sensitive or lowest range available on the analyzer. If the anticipated O2 analysis level is less than the offset value or if adequate time is not allowed for the analyzer to establish the true offset, the analyzer will in all probability display a negative reading.

Note: From the SYSTEM menu option "Display Negative (Reading)" users can toggle between ON and OFF choose by pressing the ENTER key and control whether analyzer displays negative readings.

Type of Analyzer:

Online ppb or ppm process analyzers: Analysis below 5% of the most sensitive or lowest range is normally limited to these analyzers. However, such analysis is possible with portable analyzers from Advanced Instruments due to their 60 day duty cycle and/or ability to operate during battery charging.

Portable analyzers: Typically used intermittently moving between different sample points/systems for trend analysis above 5% of the most sensitive range and, therefore, they fall into the "all other analysis" category requiring only span calibration.

Percentage analyzers: Generally used above 5% of the most sensitive range and, therefore, fall into the "all other analysis" category requiring only span calibration.

Online Recovery Time:

The priority users place on getting or keeping an analyzer online is "the" most significant factor involved in calibration and troubleshooting issues. The time it takes an analyzer to come down to a specific level after exposure to high O2 concentrations or air is significantly different if a sensor is being installed than if the sensor had been in-service at low ppm levels for more than 1 week as illustrated below:

Sensor	Calibration at Install	In-service Calibration
ppm Fuel Cell	Air to 100 ppm < 10 min Air to 10 ppm < 1 hr Air to 1 ppm < 6 hrs Air to .1 ppm < 16 hrs	Air to 1 ppm < 30 min 80 ppm to .1 ppm < 10 min 8 ppm to .05 ppm < 5 min

The above times assume the introduction of a purge gas, the lower of the available zero or sample (if known and constant) gas, with a ppm level O2 concentration less than 0.5 ppm is introduced to the analyzer following span calibration to purge (accelerate the reaction of) the O2 that has dissolved into the electrolyte inside the sensor. If zero gas is not available, substitute the sample gas and expect slightly longer recovery time.

Span Gas Selection:

The O₂ concentration of a span gas should approximate 70-90% of the full scale range dictated by the span gas, e.g. 80 ppm O₂ on the 0-100 ppm range. For optimum accuracy, the full scale range dictated by the span gas should be at least one range higher than the intended analysis range. Both of the aforementioned recommendations reduce the error induced by the tolerance of the electronic components; also, span gases with higher O₂ concentrations are more reliable and less expensive.

Conversely, if the recommended span gas is not available and air calibration is not an option, a span gas of the same full scale range and near the anticipated analysis level (approximately 10% of full scale) is acceptable with the understanding the accuracy will suffer slightly.

Use of span gas near 10% of the same full scale range for measurements at the higher end of the range has the effect of "expanding the error" by moving upscale as illustrated by Graph A and Example 1 in the Accuracy section above and is not recommended. Of course the user can always elect at his discretion to accept an accuracy error of $\pm 2-3\%$ of full scale range if no other span gas is available.

Type of Sensor:

Galvanic Fuel Cell Sensors: Analyzers utilizing these sensors can be calibrated with ambient air (20.9% or 209,000 ppm O₂) and have been proven capable of precise analysis below 0.5 ppm (500 ppb).

Note: As described above, these oxygen sensors are capable of one point calibration.

Span Gas vs. Air (Fuel Cell Sensors only):

Span gas calibration: Recommended for calibration of in-service analyzers, if the priority is the fastest online recovery time.

Air calibration: Recommended for calibration an analyzer if a new oxygen sensor is being installed or if the availability of span gas, the cost of span gas or the accuracy of a span gas is an issue. An air calibrated analyzer can be used to reliably verify a "certified" span gas, which has frequently been found to be inaccurate. For best results, select a recognized name supplier.

Note: Galvanic Fuel Cell sensors can be calibrated (using air) and brought online (using sample gas) without "purchased calibration gases" and without sacrificing accuracy - provided the analyzer is given enough time to come down to the O₂ concentration of the sample gas.

Span Calibration Adjustments:

Prematurely initiating the SPAN CALIBRATION function (when there is no intention of performing a ZERO CALIBRATION) before the analyzer reading has stabilized can result in erroneous readings as follows:

When purging an analyzer to lower ranges for span gas calibration: If the oxygen reading reaches less than 2% of the intended calibration range, enter the value of the span gas. If the oxygen reading is greater than 2% of the calibration range, add the O₂ reading to the value of the span gas (the impact of the offset on accuracy is minor but the addition allows the oxygen sensor to continue to purge down and avoid negative readings).

Note: If ZERO CALIBRATION has been performed or the analyzer has been in service, the analyzer reading should already be stable and below 2% of the calibration range.

When installing a new oxygen sensor and calibrating with air: Allow 5-10 minutes for the sensor to equilibrate in ambient air from storage packaging. Failure to do so can introduce a positive offset (electronic gain) that prevents the analyzer from displaying low ppm O₂ readings.

Menu Functions – Zero Calibration

- Factory Default Zero:** The system eliminates any previous zero calibration offset adjustment stored in memory and displays the unadjusted oxygen reading of the gas currently flowing through the analyzer.
- This function is recommended before performing a manual ZERO CALIBRATION or when troubleshooting an analyzer. This function is not recommended for subsequent periodic SPAN CALIBRATION - see Analysis Level Required above.
- Auto Zero:** Applicable only to analyzers equipped with an optional automated sample system. The system automatically closes the sample inlet valve and opens the zero inlet valve at a predetermined interval in time, see System Menu section above. It also trends the downward slope of the oxygen reading. When the slope of the oxygen reading trend approaches the factory set value, the system initiates a ZERO CALIBRATION offset adjustment and displays an oxygen reading of 0.000 or 00.00 ppm.
- Manual Zero:** Recommended for optimum accuracy. The user must ascertain that the oxygen reading has reached a stable value, see Zero Calibration Offset Adjustment Capability above, below 50% of the most sensitive or lowest range available on the analyzer before the system will accept and make a ZERO CALIBRATION offset adjustment.
- If the user attempts to initiate the ZERO CALIBRATION function while the oxygen reading is above 50% of the most sensitive or lowest range, the system displays the message "CALIBRATION FAILED" and returns to the "Sample" mode.
- Timed Zero Cal:** Subtitle only, this function represented by the following menu options are applicable only to analyzers equipped with an optional automated sample system.
- Timed Zero Cal in ____ days:** Requires the user to enter a "number" representing the interval in days before the next ZERO CALIBRATION.
- Calibration will occur at ____:** Requires the user to enter a "military time in hours and minutes" representing the time of day at which the next ZERO CALIBRATION will be initiated.

Menu Functions – Span Calibration

- Factory Default Span:** The system eliminates any previous span calibration adjustment stored in memory and displays an oxygen reading $\pm 50\%$ of the span gas value currently flowing through the analyzer.
- If the oxygen reading is outside $\pm 50\%$ of the span gas value, the system displays the message "CALIBRATION FAILED" and returns to the "Sample" mode. This feature allows the user to test the sensor's signal output without removing it from the sensor housing.
- This function is recommended before performing a SPAN CALIBRATION or when troubleshooting an analyzer.
- Span Gas Units/Value:** After initiating either Auto or Manual Span from the SPAN CALIBRATION menu, the system produces a display prompting the user to select span gas in ppb, ppm or % units, which is followed by a second display prompting the user to enter a numerical span gas value.

- Auto Span:** Applicable only to analyzers equipped with an optional automated sample system. The system automatically closes the sample inlet valve and opens the span inlet valve at a predetermined interval in time, see System Menu section above. It also trends the downward slope of the oxygen reading vs. time curve. When the slope of the oxygen reading reaches "0", the system initiates a SPAN CALIBRATION adjustment and displays an oxygen reading corresponding to the span gas value entered.
- Manual Span:** The user must ascertain that the oxygen reading has reached a stable value, see Span Calibration Adjustment above, before the system will accept and make a SPAN CALIBRATION adjustment.
- Timed Span Cal:** Subtitle only, this function represented by the following menu options are applicable only to analyzers equipped with an optional automated sample system.
- Timed Span Cal in ___ days:** Requires the user to enter a "number" representing the interval in days before the next SPAN CALIBRATION.
- Calibration will occur at ____:** Requires the user to enter a "military time in hours and minutes" representing the time of day at which the next SPAN CALIBRATION will be initiated.
- Timed Span Gas Value:** Displays the numerical span gas value and units entered when the Auto Span option was initiated.

Procedure – Zero Calibration

The analyzer is online in the Auto Range mode as described above.

Review the Analysis Level Required, Online Recovery Time, Zero Calibration Offset Adjustment and Menu Functions – Zero Calibration above before proceeding.

Assure there are no restrictions in vent line.

Regulate the pressure between 5-30 psig and set the flow rate to 2 SCFH for Fuel Cell sensors.

Allow the analyzer reading to stabilize below 50% of the most sensitive or lowest range available on the analyzer.

Advance the cursor (*) to the "Zero" option as illustrated and press the green ENTER key to accept the selection.

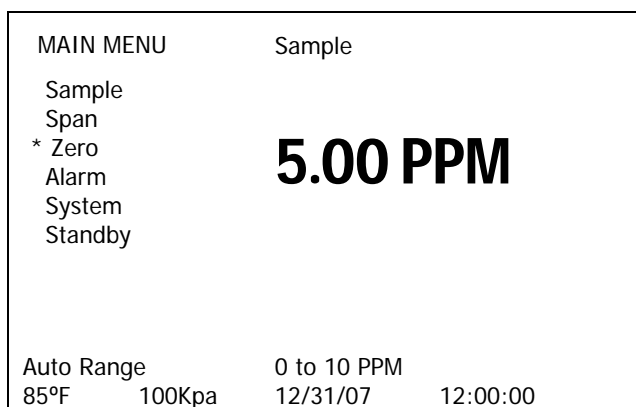

The following menu appears:

ZERO	Sample
* Factory Default	
Calibrate	
Auto Range	0 to 10 PPM
85°F 100Kpa	12/31/07 12:00:00

Advance the cursor (*) to the Factory Default Zero option and press ENTER. Within seconds the system returns to the MAIN MENU in the "Sample" mode.

MAIN MENU	Sample
Sample	
Span	
* Zero	5.00 PPM
Alarm	
System	
Standby	
Auto Range	0 to 10 PPM
85°F 100Kpa	12/31/07 12:00:00

Advance the cursor (*) to the "Zero" option and press the green ENTER key to accept the selection. The following menu appears:

ZERO	Sample
Factory Default	
* Calibrate	
Auto Range	0 to 10 PPM
85°F 100Kpa	12/31/07 12:00:00

Advance the cursor (*) to the "Manual Zero" option and press the green ENTER key to accept the selection.

The following menu appears:

ZERO CALIBRATION
IN PROGRESS . . .
5.00 PPM

After the oxygen reading has stabilized, press ENTER to complete the Zero Calibration. If the user attempts to initiate the ZERO CALIBRATION function while the oxygen reading is above 50% of the most sensitive or lowest range, the system displays the message "CALIBRATION FAILED" and returns to the "Sample" mode.

CALIBRATION
FAILED

CALIBRATION
COMPLETE

Procedure – Span Calibration

The analyzer is online in the Auto Range mode as described above.

Review the Intervals, Online Recovery Time, Span Gas Selection, Type of Sensor, Span Calibration Adjustment and Menu sections above, before proceeding.

Allow the analyzer reading to stabilize, Advance the cursor (*) to the "Span" option as illustrated and press the green ENTER key to accept the selection.

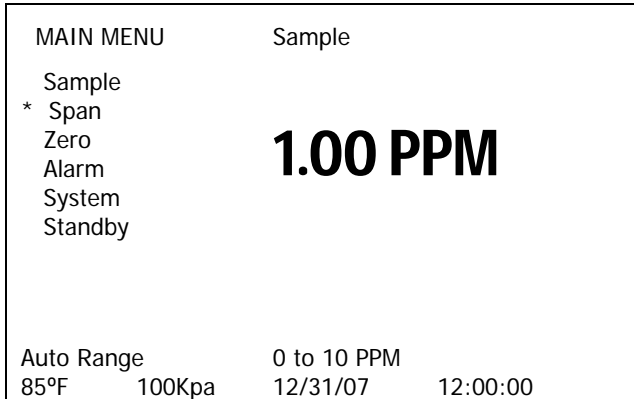

The following menu appears:

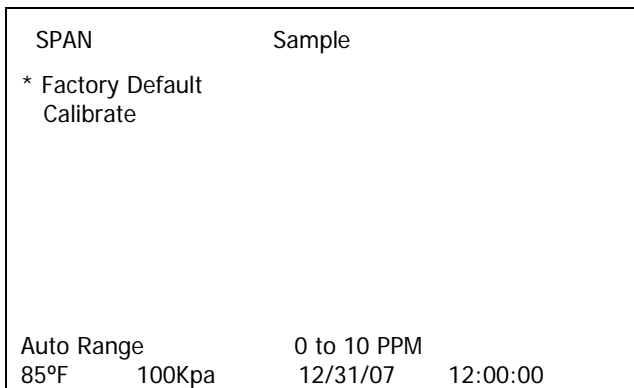

Advance the cursor (*) to the Factory Default Span option and press ENTER. Within seconds the system returns to the MAIN MENU in the "Sample" mode.

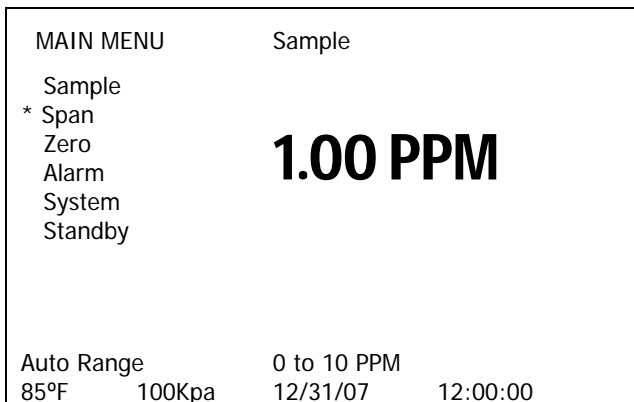

At this point, the user must decide whether to perform a Span Gas or Air Calibration, see above.

Note: If the analyzer is to be calibrated with instrument or compressed air follow the Span Gas Calibration procedure below.

Advanced Instruments Inc.

Span Gas Calibration: Assure there are no restrictions in vent line.

Regulate the pressure between 5-30 psig and set the flow rate to 2 SCFH for Fuel Cell sensors.

If the analyzer is equipped with a SAMPLE/BYPASS valve, place it in the BYPASS position.

Disconnect the sample gas line and install the span gas line.

Keep the SAMPLE/BYPASS valve in the BYPASS position.

Allow the span gas to flow for 1-2 minutes to purge the gas lines inside the analyzer.

Place the SAMPLE/BYPASS valve in the SAMPLE position.

If the analyzer is not equipped with a SAMPLE/BYPASS valve:

Allow the span gas to flow for 1-2 minutes to purge the air trapped in the span gas line.

Disconnect the sample gas line and install the purged span gas line.

Air Calibration: Access the interior of the analyzer by opening the front door of the analyzer.

Using the 5/16 wrench supplied loosen but do not remove the clamp bolt located in the center of the bracket attached to bottom section with the elbow fittings.

Rotate the upper section of the sensor housing 90° to disengage from the clamp.



Remove the upper section by pulling it straight up and let it rest on your 1st and 2nd fingers.

With your other hand remove the oxygen sensor, place it in the upper section of the sensor housing ensuring the PCB contacts the two gold pins and use your thumb to hold the sensor and upper section of the sensor housing together.

The sensor is now exposed to ambient air, connected to the analyzer electronics and ready for calibration.

Allow the sample gas to continue to flow if possible, otherwise close the FLOW valve but do not disconnect the sample gas line.

Caution: Allow the reading to stabilize before proceeding. A premature SPAN CALIBRATION adjustment can result in erroneous readings, see the Span Calibration Adjustment section above.

It is highly recommended that the analyzer be connected to an external recording device, if practical, to ensure that the analyzer reading reaches a stable value (10-20 minutes) before accepting the span calibration.

Advance the cursor (*) to the "Span" option as illustrated and press the green ENTER key to accept the selection.

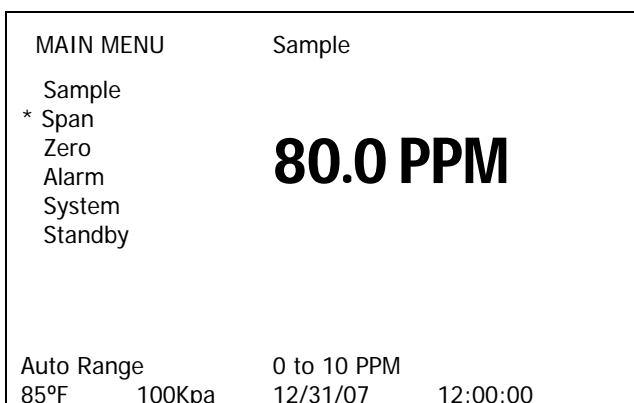

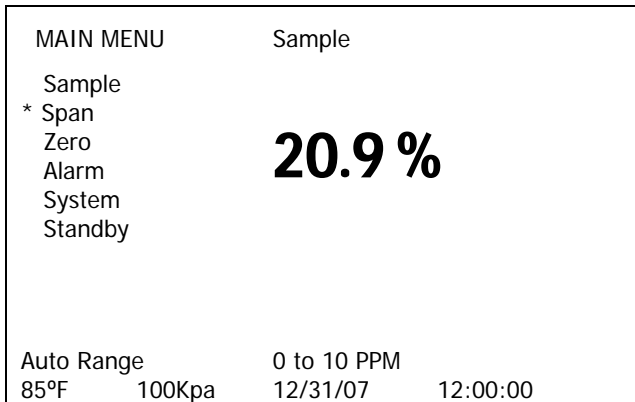

The following menu appears:

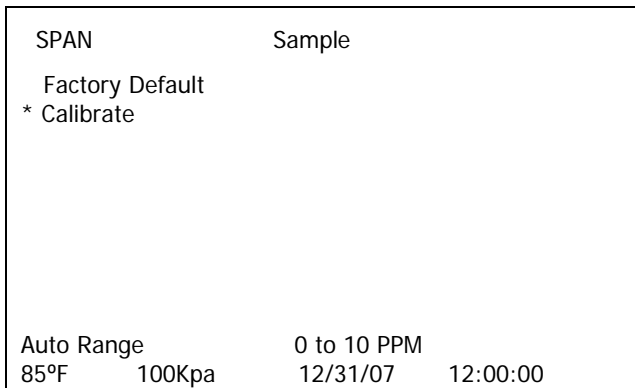

Advance the cursor (*) to the "Manual Span" option and press the green ENTER key to accept the selection. The following menu appears:

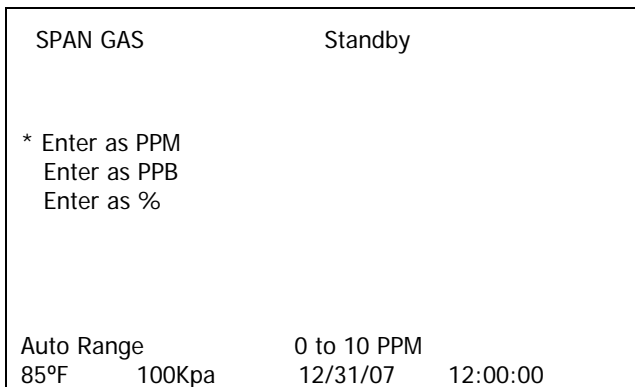

Enter span gas units appropriate to the numerical span gas value and press ENTER key.
Note: Select "Enter as %" for air calibration.

The following display appears:

```

                Sample
080.00 PPM

Press UP or DOWN keys to change values

Select ENTER to save, ESC to return

Auto Range      0 to 10 PPM
85°F    100Kpa   12/31/07  12:00:00
```

Press the ENTER key to move the cursor (underscore) to the right to the digit to be changed. Press the UP or DOWN key until the desired number appears in digit field. Repeat as necessary to enter the numerical span value. Press the ENTER key to accept and save the span gas value.

The system then initiates the SPAN CALIBRATION function and the following menu appears:

```

                CALIBRATION
                IN PROGRESS . . .

SPAN VALUE          ACTUAL O2 VALUE
```

After the oxygen reading has stabilized, press ENTER to complete the Span Calibration.

If the oxygen reading is outside $\pm 50\%$ of the span gas value, the system displays the message "CALIBRATION FAILED" and returns to the "Sample" mode.

```

                CALIBRATION
                FAILED
```

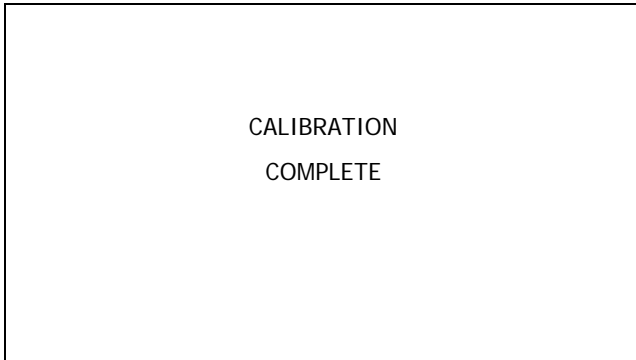

Following a successful calibration, the system returns to the "Sample" mode and it will be necessary to reconnect the sample gas line as follows:

Span Gas Calibration:

Assure there are no restrictions in vent line.
Regulate the pressure between 5-30 psig and set the flow rate to 2 SCFH for Fuel Cell sensors.
If the analyzer is equipped with a SAMPLE/BYPASS valve, place it in the BYPASS position.
Disconnect the span gas line and install the sample gas line.
Keep the SAMPLE/BYPASS valve in the BYPASS position.
Allow the sample gas to flow for 1-2 minutes to purge the gas lines inside the analyzer.
Place the SAMPLE/BYPASS valve in the SAMPLE position.

If the analyzer is not equipped with a SAMPLE/BYPASS valve:
Allow the sample gas to flow for 1-2 minutes to purge the air trapped in the sample gas lines.
Disconnect the span gas line and install the purged sample gas line.

Air Calibration:

The sample gas should still be flowing, if necessary open the FLOW valve.
Reassemble the sensor housing.
Place the sensor face down in the bottom section of the sensor housing.
Ensure the o-ring is in place.

Install the upper section by gently pushing it straight down.

Ensure the PCB contacts the two gold pins.

Rotate the upper section of the sensor housing 90° to engage the clamp.

Using the 5/16 wrench supplied tighten the clamp bolt located in the center of the bracket attached to bottom section with the elbow fittings to secure the sensor housing.

Close the front door of the analyzer.

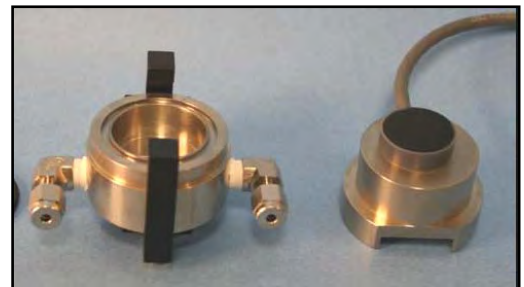

Sampling

Process ppm oxygen analyzers require positive pressure to flow the sample gas by the sensor to measure the oxygen concentration in a sample gas. See Pressure & Flow under Installation in section 3 Safety Guidelines. To assure optimal performance: connect gas lines with metal tubing, quality compression type fittings to minimize leaks, follow pressure and flow recommendations and avoid exposing the sensor to air and high oxygen concentrations for prolonged periods of time (this does not include the 5 minutes it should take to air calibrate the analyzer once a week).

The sample must be properly presented to the sensor to ensure an accurate measurement. In standard form the GPR-1600 is designed with a sample system that complements the performance capabilities of the advanced oxygen sensor and enables the user to isolate the sensor from exposure to high oxygen concentration which results in a substantial increase in user productivity.

For ppb and ppm trace oxygen measurements, the sensor is exposed to sample gas that must flow or be drawn through the analyzer's internal sample system. This unique sample system, when operated accordingly to the instructions in this Owner's Manual, can significantly increase user productivity by minimizing the sensor's exposure to ambient air or high oxygen concentrations which contribute to the significant amount of downtime associated with competitive analyzers.

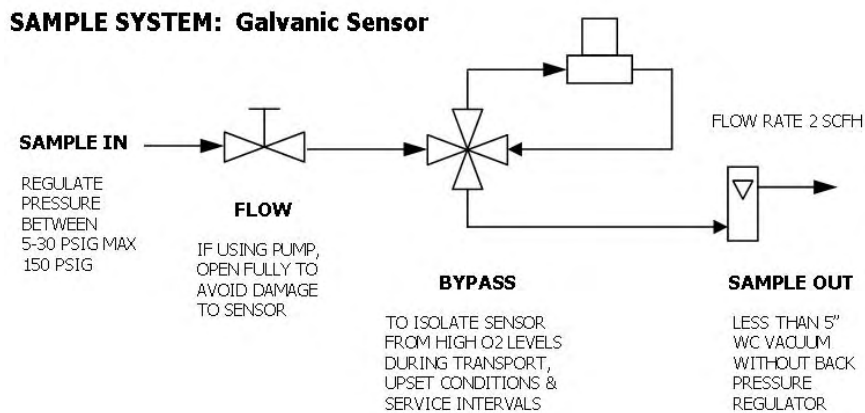

The advantages of the bypass sample system include:

- Supplying the analyzer with the sensor it was qualified with.
- Isolating the sensor during transport, calibration and maintenance intervals when changing gas line connections.
- Isolating the sensor from exposure to high oxygen levels during upset conditions which extend sensor life.
- Purging the air (or high oxygen levels above 1,000 ppm) trapped in the gas lines following a process upset.

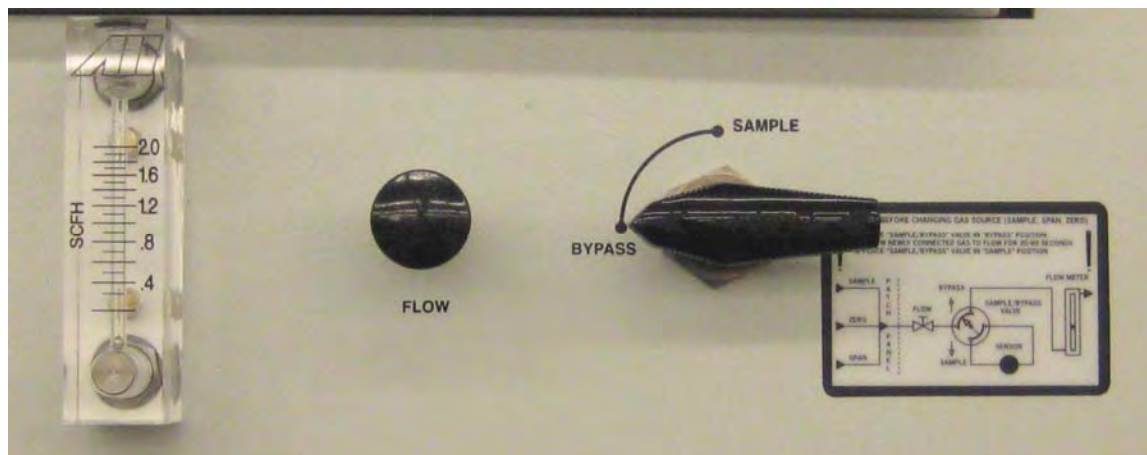

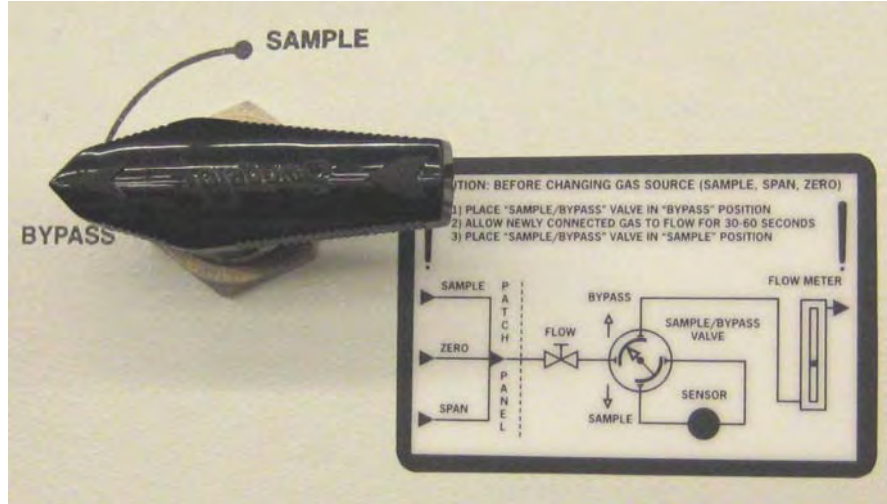

Procedure:

Following calibration the analyzer returns to the SAMPLE mode after 30 seconds.

1. Select the desired sampling mode - auto or if manual, the range that provides maximum resolution – as described above.
2. Use metal tubing to transport the sample gas to the analyzer.
3. The main consideration is to eliminate air leaks which can affect oxygen measurements above or below the 20.9% oxygen concentration in ambient air - ensure the sample gas tubing connections fit tightly into the 1/8" male NPT to tube adapter, and, the NPT end is taped and securely tightened into the mating male quick disconnect fittings which mate with the female fittings on the analyzer
4. Assure there are no restrictions in the sample line.
5. For sample gases under positive pressure the user must provide a means of regulating the inlet pressure between 5-30 psig and setting the flow rate of the sample gas at 2 SCFH (flow rates between .5 and 5 SCFH are acceptable).
6. For sample gases under atmospheric or slightly negative pressure an optional sampling pump is recommended to draw the sample into the analyzer. Generally, no pressure regulation or flow control device is involved.
7. **Caution:** If the analyzer is equipped with an optional sampling pump and is intended for use in both positive and atmospheric/slightly negative pressure applications where a flow meter valve is involved – ensure the valve is completely open when operating the sampling pump. Refer to the Pressure & Flow section above.
8. Assure the sample is adequately vented for optimum response and recovery – and safety.
9. Allow the oxygen reading to stabilize for approximately 10 minutes at each sample point.

To avoid erroneous oxygen readings and damaging the sensor:

- Do not place your finger over the vent to test the flow indicator when gas is flowing to the sensor. Removing your finger generates a vacuum on the sensor and may damage the sensor (voiding the sensor warranty).
- Assure there are no restrictions in the sample or vent lines
- Avoid drawing a vacuum that exceeds 14" of water column pressure – unless done gradually
- Avoid excessive flow rates above 5 SCFH.
- Avoid sudden releases of backpressure that can severely damage the sensor.
- Avoid the collection of particulates, liquids or condensation collect on the sensor that could block the diffusion of oxygen into the sensor.
- If the analyzer is equipped with an optional integral sampling pump (positioned downstream of the sensor) and a flow control metering valve (positioned upstream of the sensor), completely open the flow control metering valve to avoid drawing a vacuum on the sensor and placing an undue burden on the pump.

Standby

The analyzer has no special storage requirements. The sensor should remain connected during storage periods. Store the analyzer with the power OFF. If storing for an extended period of time protect the analyzer, cable and sensor from dust, heat and moisture.

6 Maintenance

There are no moving parts in the analyzer given the modular nature of the electronics and sensor. Cleaning the electrical contacts when replacing the sensor is the extent of the maintenance requirements of this analyzer. **Serviceability:** Except for replacing the oxygen sensor, there are no parts inside the analyzer for the operator to service. Only trained personnel with the authorization of their supervisor should conduct maintenance.

Sensor Replacement:

Periodically, the oxygen sensor will require replacement. The operating life is determined by a number of factors that are influenced by the user and therefore difficult to predict. The sections dealing with Specification and Installation Considerations define the normal operating conditions and expected life of the standard sensor utilized by the GPR-1600 analyzer. As a general guideline, expected sensor life is inversely proportional to changes in oxygen concentration, pressure and temperature.

Caution: DO NOT open the oxygen sensor. The sensor contains a corrosive liquid electrolyte that could be harmful if touched or ingested, refer to the Material Safety Data Sheet contained in the Owner's Manual appendix. Avoid contact with any liquid or crystal type powder in or around the sensor or sensor housing, as either could be a form of electrolyte. Leaking sensors should be disposed of in accordance with local regulations.

Procedure:

1. Determine your calibration requirements by reviewing the ZERO CALIBRATION and SPAN CALIBRATION discussions in section 5 Operation. Consult the analyzer specifications for recovery times and span gas values.
2. Open the door of the analyzer to access the sensor housing.
3. Using the 5/16 wrench supplied loosen but do not remove the clamp bolt located in the center of the bracket attached to bottom section with the elbow fittings.
4. Rotate the upper section of the sensor housing 90° to disengage from the clamp.
5. Remove the upper section by pulling it straight up and place it on a smooth surface.
6. Remove the old oxygen sensor and dispose of it as you would a battery.
7. Remove the o-ring from the bottom section of the sensor housing.
8. Wipe the o-ring with a damp lint free cloth.
9. Lightly lubricate the o-ring with vacuum grease for optimal seal.
10. Reinstall the o-ring into the bottom section of the sensor housing.
11. From the MAIN MENU select AUTO RANGING as described above.
12. If equipped with SAMPLE/BYPASS valve, place it in the SAMPLE position.
13. Set the flow rate to 2 SCFH.
14. Connect zero gas or low oxygen content sample gas line to purge the lines and the sensor of oxygen (once reinstalled).
15. **Caution:** Minimize the time the new sensor is exposed to ambient air.
16. Remove the new oxygen sensor from the shipping bag.
17. Remove the red label and the gold ribbon (shorting device) from the PCB at the rear of the sensor.
18. Place the new sensor in the bottom section of the sensor housing with the PCB facing up.
19. Place the upper section of the sensor housing over the sensor.
20. Gently push the upper section downward and rotate 90° to engage the clamp.
21. Finger tighten the clamp bolt and one full turn with the 5/16 wrench to compressed the o-ring seal.
22. Expect the analyzer reading to recover to ppb levels as described in the analyzer specification.
23. Perform the desired calibration(s).
24. Begin sampling once the analyzer has reached the value of the purge gas.

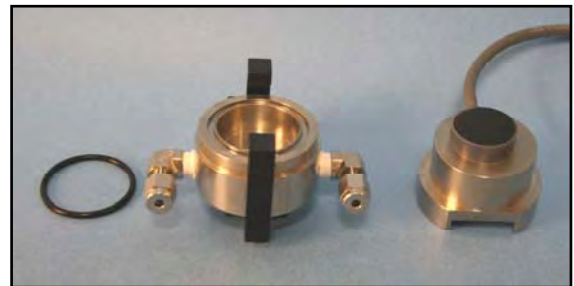
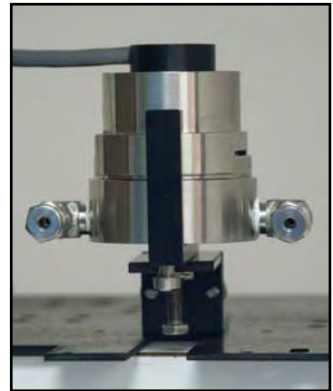

7 Spare Parts

Recommended spare parts for the GPR-1600 Oxygen Analyzer include:

Item No.	Description
GPR-12-333	ppm Oxygen Sensor
XLT-12-333	ppm Oxygen Sensor

Other spare parts:

A-1004-1-36	Housing Sensor Stainless Steel
A-1016-A	Housing Sensor Bottom Assembly Stainless Steel
B-2762-A-1-36	Housing Sensor Upper Assembly Stainless Steel
MTR-1011	Meter Digital Panel LCD Backlight
ORNG-1007	O-ring 3/32 x 1-3/8 x 1-9/16 Viton
A-1146-10	PCB Assembly Main / Display
A-1174-10	PCB Assembly AC Power Supply / Interconnection Alarms, 4-20mA Range ID
A-1174-10C	PCB Assembly AC Power Supply / Interconnection w/o Alarms, Relay Contacts Range ID

8 Troubleshooting

Symptom	Possible Cause	Recommended Action
Slow recovery	At installation, defective sensor Air leak in sample system connection(s) Abnormality in zero gas Damaged in service - prolonged exposure to air, electrolyte leak Sensor nearing end of life	Replace sensor if recovery unacceptable or O ₂ reading fails to reach 10% of lowest range Leak test the entire sample system: Vary the flow rate, if the O ₂ reading changes inversely with the change in flow rate indicates an air leak - correct source of leak Qualify zero gas (using portable analyzer) Replace sensor Replace sensor
High O ₂ reading after installing or replacing sensor	Analyzer calibrated before sensor stabilized caused by: 1) Prolonged exposure to ambient air, worse if sensor was unshorted 2) Air leak in sample system connection(s) 3) Abnormality in zero gas	Allow O ₂ reading to stabilize before making the span/calibration adjustment Continue purge with zero gas Leak test the entire sample system (above) Qualify zero gas (using portable analyzer)
High O ₂ reading Sampling	Flow rate exceeds limits Pressurized sensor Improper sensor selection	Correct pressure and flow rate Remove restriction on vent line Replace GPR/PSR sensor with XLT sensor when CO ₂ or acid gases are present
Response time slow	Air leak, dead legs, distance of sample line, low flow rate, volume of optional filters and scrubbers	Leak test (above), reduce dead volume or increase flow rate
O ₂ reading doesn't agree to expected O ₂ values	Pressure and temperature of the sample is different than span gas Abnormality in gas	Calibrate the analyzer (calibrate at pressure and temperature of sample) Qualify the gas (use a portable analyzer)

Advanced Instruments Inc.

Symptom	Possible Cause	Recommended Action
Erratic O ₂ reading or No O ₂ reading	Change in sample pressure	Sensors without PCB use mV setting. Calibrate the analyzer (calibrate at pressure and temperature of sample)
	Dirty electrical contacts in upper section of sensor housing	Clean contacts with alcohol (minimize exposure time of MS sensor to ambient air to extent possible)
	Corroded solder joints on sensor PCB from corrosive sample or electrolyte leakage from sensor	Replace sensor and return sensor to the factory for warranty determination
	Corroded spring loaded contact in upper section of sensor housing from liquid in sample or electrolyte leakage from sensor	Upper section of sensor housing: Clean contacts with alcohol, flow sample or zero gas for 2-3 hours to flush sample system and sensor housing Sensor: Replace if leaking and return it to the factory for warranty determination
	Liquid covering sensing area	Wipe with alcohol and lint free towel or flow sample or zero gas for 2-3 hours to flush Replace GPR/PSR sensor with XLT sensor when CO ₂ or acid gases are present. Consult factory.
	Improper sensor selection	Replace sensor and install scrubber Consult factory. Replace sensor
Erratic O ₂ reading or Negative O ₂ reading or No O ₂ reading accompanied by electrolyte leakage	Pressurizing the sensor by flowing gas to the sensor with the vent restricted or SHUT OFF valve closed and suddenly removing the restriction draws a vacuum on the sensor	Zero the analyzer. If not successful replace the sensor
	or partially opening the valves upstream of the analyzer when using a pump downstream of the analyzer to draw sample from a process at atmospheric pressure or a slight vacuum. Placing a vacuum on the sensor in excess 4" of water column is strongly discouraged.	Avoid drawing a vacuum on the sensor, a pressurized sensor may not leak but still produce negative readings.
	A premature adjustment of the ZERO OFFSET potentiometer is a common problem	From MAIN MENU select DEFAULT ZERO

Advanced Instruments Inc.

Purpose: SPAN CALIBRATION of digital (reference to analog) ppm O₂ analyzer already in-service.
TROUBLESHOOT ppm O₂ analyzer to confirm response and stability under controlled conditions.

Preliminary Test

1.) Confirm metal sample system components - no plastic.
 2.) Leak Test: Vary analyzer flow rate up/down and observe reading.

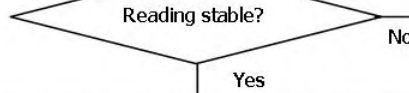

1.) Tighten and 'Snoop' connections
 2.) STOP if reading is not stable and contact factory.

Set-up

1.) Place analyzer SAMPLE/BYPASS valve(s) in BYPASS mode, see (a) below.
 2.) Select AUTO-RANGING mode or MANUALLY select range for span gas
 3.) Perform DEFAULT ZERO or MANUALLY eliminate previous zero adjustments
 4.) Perform DEFAULT SPAN
 Note: Zeroing the analyzer is only recommended for continuous analysis < 1 ppm which normally excludes portable analyzers - constantly changing gas lines.

Connect Gas Line

1.) Connect the span gas line or if equipped with a 3-way SAMPLE/SPAN valve place it in the SPAN mode.
 2.) Allow the span gas to flow for 5-10 minutes to purge the air (20.9% O₂) from inside the span gas line - during connection or leaks during standby.

If analyzer is not equipped with BYPASS SAMPLE SYSTEM, see (a) below:
 1.) Purge the span gas line before connecting to the analyzer.
 2.) Connect the gas lines as quickly as possible - some air will be introduced.
 3.) Allow extra time for the reading to stabilize - the sensor was exposed to air.
 4.) When off-line, maintain gas flow thru analyzer or cap connections (inlet first) to avoid damaging the sensor by exposing it to air (20.9% O₂).

Calibration Procedure

1.) Place analyzer SAMPLE/BYPASS valve(s) in SAMPLE mode, see (a) below.
 2.) Allow the reading to stabilize, normally 2-10 minutes unless exposed to air.
 3.) Once stable - initiate CALIBRATION routine (or unlock and adjust SPAN knob) from MAIN MENU, select SPAN CALIBRATE, enter SPAN VALUE, press ENTER.



1.) Confirm span gas with portable analyzer calibrated with ambient air.
 2.) Repeat at least twice.
 3.) Replace sensor and repeat once.
 4.) If unsuccessful with new sensor, STOP and contact factory.

Troubleshooting

Note: SPAN CALIBRATION is complete and for TROUBLESHOOTING purposes demonstrates the sensor/analyzer responds normally - under controlled conditions.
 For TROUBLESHOOTING purposes only: Connect one of the analyzer's signal outputs to an external recording device and continue the flow of span gas for 1-2 hours.

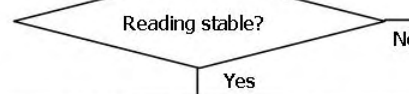

1.) Replace sensor and repeat once.
 2.) If unsuccessful with new sensor, STOP and contact factory.

Sampling

1.) Place analyzer SAMPLE/BYPASS valve(s) in BYPASS mode, see (a) below.
 2.) Connect Gas Line - as above for sample gas.
 3.) Place analyzer SAMPLE/BYPASS valve(s) in SAMPLE mode, see (a) below.

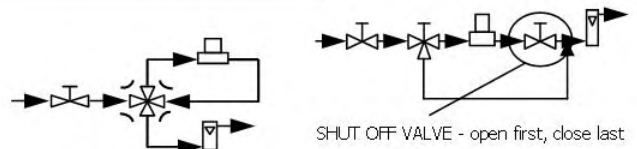

(a) Analyzer equipped (or supplied by user) with either type of BYPASS SAMPLE SYSTEM:

SHUT OFF VALVE - open first, close last

Advanced Instruments Inc.

Purpose: AIR CALIBRATION of digital (reference to analog) ppm O₂ analyzer (only use for 0-25% range):

- a.) when installing a new sensor,
- b.) when span gas (instrument air piped to sensor - address as SPAN CALIBRATION) is not available or
- c.) when it is advantageous from a troubleshooting standpoint to employ a portable analyzer that has been calibrated with ambient air as a "referee" to confirm other analyzers or span gas values.

Note 1: The drawback to air calibration is the time required for a ppm sensor exposed to air (1-2 minutes for calibration purposes) to recover to the 0-10 ppm range and the added requirement for low ppm O₂ concentration gas (sample, zero, purge or span) to purge the sensor of the oxygen that dissolves into the sensor's electrolyte when exposed to air (20.9% or 209,000 ppm O₂)

Note 2: Expected recovery time to 10 ppm on 1-2 ppm purge gas is < 1 hr at installation and < 20 minutes for an analyzer that has been in-service > 2 weeks. For higher ppm analysis, expected recovery time to 80-100 ppm on 1-2 ppm purge gas is < 10 minutes.

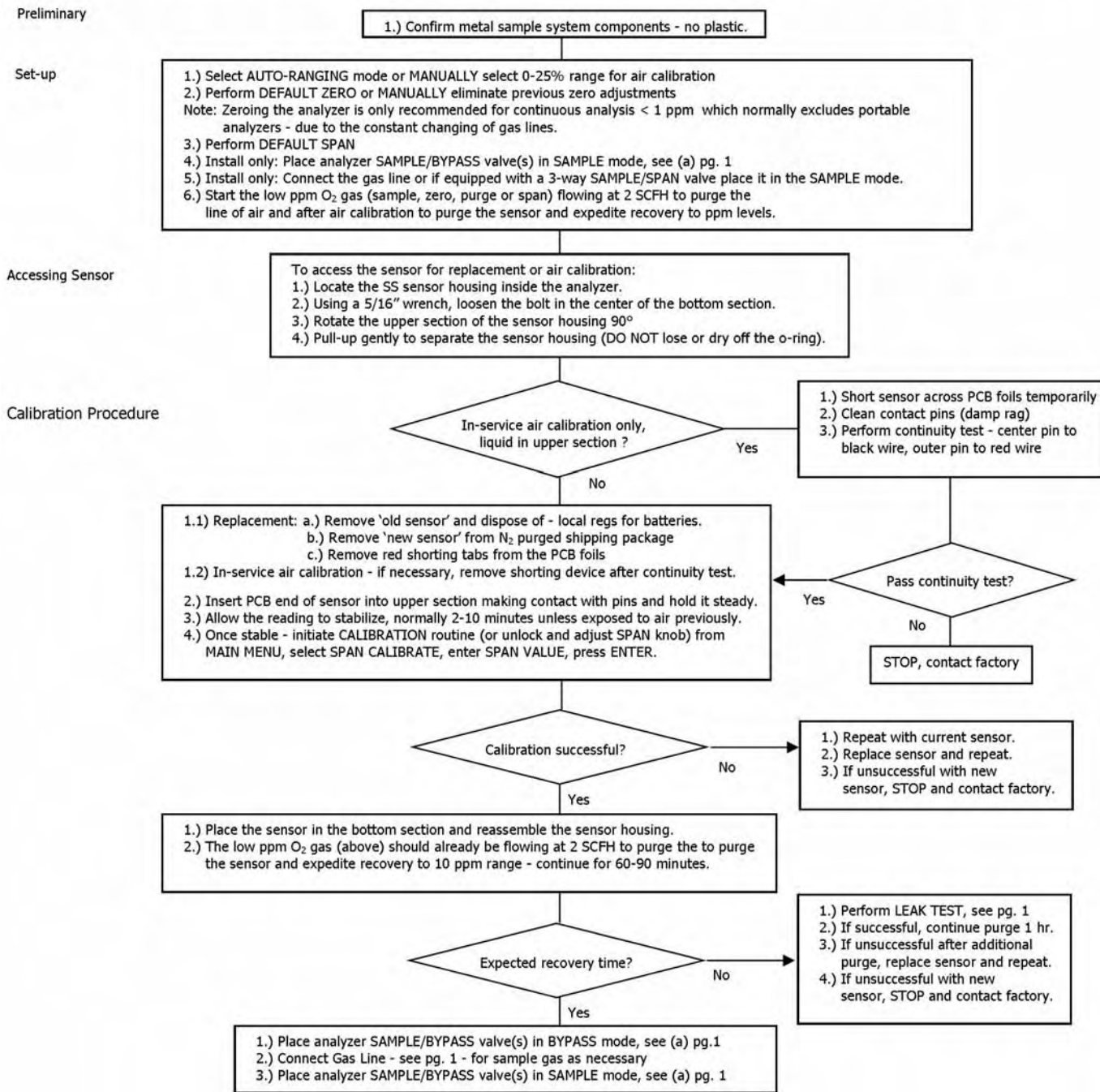

9 Warranty

The design and manufacture of GPR Series oxygen analyzers, monitors and oxygen sensors are performed under a certified Quality Assurance System that conforms to established standards and incorporates state of the art materials and components for superior performance and minimal cost of ownership. Prior to shipment every analyzer is thoroughly tested by the manufacturer and documented in the form of a Quality Control Certification that is included in the Owner's Manual accompanying every analyzer. When operated and maintained in accordance with the Owner's Manual, the units will provide many years of reliable service.

Coverage

Under normal operating conditions, the monitor, analyzers and sensor are warranted to be free of defects in materials and workmanship for the period specified in accordance with the most recent published specifications, said period begins with the date of shipment by the manufacturer. The manufacturer information and serial number of this analyzer are located on the rear of the analyzer. Advanced Instruments Inc. reserves the right in its sole discretion to invalidate this warranty if the serial number does not appear on the analyzer.

If your Advanced Instruments Inc. monitor, analyzer and/or oxygen sensor is determined to be defective with respect to material and/or workmanship, we will repair it or, at our option, replace it at no charge to you. If we choose to repair your purchase, we may use new or reconditioned replacement parts. If we choose to replace your Advanced Instruments Inc. analyzer, we may replace it with a new or reconditioned one of the same or upgraded design. This warranty applies to all monitors, analyzers and sensors purchased worldwide. It is the only one we will give and it sets forth all our responsibilities. There are no other express warranties. This warranty is limited to the first customer who submits a claim for a given serial number and/or the above warranty period. Under no circumstances will the warranty extend to more than one customer or beyond the warranty period.

Limitations

Advanced Instruments Inc. will not pay for: loss of time; inconvenience; loss of use of your Advanced Instruments Inc. analyzer or property damage caused by your Advanced Instruments Inc. analyzer or its failure to work; any special, incidental or consequential damages; or any damage resulting from alterations, misuse or abuse; lack of proper maintenance; unauthorized repair or modification of the analyzer; affixing of any attachment not provided with the analyzer or other failure to follow the Owner's Manual. Some states and provinces do not allow limitations on how an implied warranty lasts or the exclusion of incidental or consequential damages, these exclusions may not apply.

Exclusions

This warranty does not cover installation; defects resulting from accidents; damage while in transit to our service location; damage resulting from alterations, misuse or abuse; lack of proper maintenance; unauthorized repair or modification of the analyzer; affixing of any label or attachment not provided with the analyzer; fire, flood, or acts of God; or other failure to follow the Owner's Manual.

Service

Call Advanced Instruments Inc. at 909-392-6900 (or e-mail info@aii1.com) between 7:30 AM and 5:00 PM Pacific Time Monday thru Thursday or before 12:00 pm on Friday. Trained technicians will assist you in diagnosing the problem and arrange to supply you with the required parts. You may obtain warranty service by returning you analyzer, postage prepaid to:

Advanced Instruments Inc.
2855 Metropolitan Place
Pomona, Ca 91767 USA

Be sure to pack the analyzer securely. Include your name, address, telephone number, and a description of the operating problem. After repairing or, at our option, replacing your Advanced Instruments Inc. analyzer, we will ship it to you at no cost for parts and labor.

10 MSDS Material Safety Data Sheet

Product Identification

Product Name	Oxygen Sensor Series - PSR, GPR, AII, XLT
Synonyms	Electrochemical Sensor, Galvanic Fuel Cell
Manufacturer	Analytical Industries Inc., 2855 Metropolitan Place, Pomona, CA 91767 USA
Emergency Phone Number	909-392-6900
Preparation / Revision Date	January 1, 1995
Notes	Oxygen sensors are sealed, contain protective coverings and in normal conditions do not present a health hazard. Information applies to electrolyte unless otherwise noted.

Specific Generic Ingredients

Carcinogens at levels > 0.1%	None
Others at levels > 1.0%	Potassium Hydroxide or Acetic Acid, Lead
CAS Number	Potassium Hydroxide = KOH 1310-58-3 or Acetic Acid = 64-19-7, Lead = Pb 7439-92-1
Chemical (Synonym) and Family	Potassium Hydroxide (KOH) – Base or Acetic Acid (CH ₃ CO ₂ H) – Acid, Lead (Pb) – Metal

General Requirements

Use	Potassium Hydroxide or Acetic Acid - electrolyte, Lead - anode
Handling	Rubber or latex gloves, safety glasses
Storage	Indefinitely

Physical Properties

Boiling Point Range	KOH = 100 to 115° C or Acetic Acid = 100 to 117° C
Melting Point Range	KOH -10 to 0° C or Acetic Acid – NA, Lead 327° C
Freezing Point	KOH = -40 to -10° C or Acetic Acid = -40 to -10° C
Molecular Weight	KOH = 56 or Acetic Acid – NA, Lead = 207
Specific Gravity	KOH = 1.09 @ 20° C, Acetic Acid = 1.05 @ 20° C
Vapor Pressure	KOH = NA or Acetic Acid = 11.4 @ 20° C
Vapor Density	KOH – NA or Acetic Acid = 2.07
pH	KOH > 14 or Acetic Acid = 2-3
Solubility in H ₂ O	Complete
% Volatiles by Volume	None
Evaporation Rate	Similar to water
Appearance and Odor	Aqueous solutions: KOH = Colorless, odorless or Acetic Acid = Colorless, vinegar-like odor

Fire and Explosion Data

Flash and Fire Points	Not applicable
Flammable Limits	Not flammable
Extinguishing Method	Not applicable
Special Fire Fighting Procedures	Not applicable
Unusual Fire and Explosion Hazards	Not applicable

Reactivity Data

Stability	Stable
Conditions Contributing to Instability	None
Incompatibility	KOH = Avoid contact with strong acids or Acetic Acid = Avoid contact with strong bases
Hazardous Decomposition Products	KOH = None or Acetic Acid = Emits toxic fumes when heated
Conditions to Avoid	KOH = None or Acetic Acid = Heat

Spill or Leak

Steps if material is released

Sensor is packaged in a sealed plastic bag, check the sensor inside for electrolyte leakage. If the sensor leaks inside the plastic bag or inside an analyzer sensor housing do not remove it without rubber or latex gloves and safety glasses and a source of water. Flush or wipe all surfaces repeatedly with water or wet paper towel (fresh each time).

Disposal

In accordance with federal, state and local regulations.

Health Hazard Information

Primary Route(s) of Entry

Ingestion, eye and skin contact

Exposure Limits

Potassium Hydroxide - ACGIH TLV 2 mg/cubic meter or Acetic Acid - ACGIH TLV / OSHA PEL 10 ppm (TWA), Lead - OSHA PEL .05 mg/cubic meter

Ingestion

Electrolyte could be harmful or fatal if swallowed. KOH = Oral LD50 (RAT) = 2433 mg/kg or Acetic Acid = Oral LD50 (RAT) = 6620 mg/kg

Eye

Electrolyte is corrosive and eye contact could result in permanent loss of vision.

Skin

Electrolyte is corrosive and skin contact could result in a chemical burn.

Inhalation

Liquid inhalation is unlikely.

Symptoms

Eye contact - burning sensation. Skin contact - soapy slick feeling.

Medical Conditions Aggravated

None

Carcinogenic Reference Data

KOH and Acetic Acid = NTP Annual Report on Carcinogens - not listed; LARC Monographs - not listed; OSHA - not listed

Other

Lead is listed as a chemical known to the State of California to cause birth defects or other reproductive harm.

Special Protection Information

Ventilation Requirements

None

Eye

Safety glasses

Hand

Rubber or latex gloves

Respirator Type

Not applicable

Other Special Protection

None

Special Precautions

Precautions

Do not remove the sensor's protective Teflon and PCB coverings. Do not probe the sensor with sharp objects. Wash hands thoroughly after handling. Avoid contact with eyes, skin and clothing. Empty sensor body may contain hazardous residue.

Transportation

Not applicable